



FC501

**Addressable
Fire
Control Panels**

Installation Manual

This Fire Control panel can only be programmed using the Software **FireClass** Console release 1.0 or higher. Control panel FW ver. 1.0 or higher.

TYCO shall not assume the responsibility for damage arising from improper application or use.

Installation of this Control panel must be carried out strictly in accordance with the instructions described in this manual and in compliance with the local laws and bylaws in force.

The **FC501-L**, **FC501-H** and **FC501-HK** Fire Control panels comply with the essential requirements of standards **EN54-2**; **EN54-4** and **EN54-21**.

Contents of the box

The control panel is contained in a box. Listed below are the contents:

- the plastic cabinet (backplate and cover) with the motherboard and the power supply Switching assembled.
- The Quick Start Guide.
- A transparent plastic bag containing:
 - A CD-ROM containing the Installation and User manuals and the FireClass software console to manage the panel;
 - A second transparent plastic bag containing:
 - the KST thermal Probe;
 - Two 3.9 kOhm resistors;
 - a red and a black cable L = 300 mm with a faston terminal to connect batteries;
 - a black cable L = 300 mm with two faston terminal to connect batteries. Proceed carefully to unpack the contents and dispose of recyclable materials in accordance with the local law.

Recycling information

The manufacturer recommends that customers dispose of their used equipment (panels, detectors, sirens, and other devices) in an environmentally sound manner. Potential methods include reuse of parts or whole products and recycling of products, components, and/or materials.

Waste Electrical and Electronic Equipment (WEEE) Directive



■ In the European Union, this label indicates that this product should NOT be disposed of with household waste. It should be deposited at an appropriate facility to enable recovery and recycling.

NOTE- The FC501 Fire control panel can support several addressable devices (Detectors, Modules, Manual call Points, etc). The present manual includes the instructions for their programming, but for further information on those devices and their accessories, please visit: www.fireclass.net, logging in the **Reserved Area**, under **Installation Manuals**.

The manufacturer reserves the right to change the technical specifications of these products without prior notice.

 0051	
Tyco Fire & Security GmbH Victor von Bruns-Strasse 21 8212 Neuhausen am Rheinfeld Switzerland 13 DoP-2015-4218 (FC501-L) DoP-2015-4219 (FC501-H)/(FC501-HK)	
EN 54-2:1997+A1:2006 EN54-4 : 1997+A1:2002+A2:2006 EN 54-21 Control and indicating equipment with integrated power supply equipment for fire detection and fire alarm systems for buildings with alarm transmission and fault warning routing equipment.	
EXPECTED OPTIONS Fault signals from points Dependencies on more than one alarm signal: type A and B Delays to outputs Disablement of addressable point Test condition Output to fire alarm device	
EN 54-2 ESSENTIAL CHARACTERISTICS	
Performance under fire conditions	Passed
Response delay (response time to fire)	Passed
Operational reliability	Passed
Durability of operational reliability, Temperature resistance	Passed
Durability of operational reliability, Vibration resistance	Passed
Durability of operational reliability, Electrical stability	Passed
Durability of operational reliability, humidity resistance	Passed
EN 54-21 ESSENTIAL CHARACTERISTICS	
Performance of transmission	Passed
Operational reliability	Passed
Durability of operational reliability, Temperature resistance	Passed
Durability of operational reliability, Vibration resistance	Passed
Durability of operational reliability, Electrical stability	Passed
Durability of operational reliability, humidity resistance	Passed
EN 54-4 ESSENTIAL CHARACTERISTICS	
Performance of power supply	Passed
Operational reliability	Passed
Durability of operational reliability, Temperature resistance	Passed
Durability of operational reliability, Vibration resistance	Passed
Durability of operational reliability, Electrical stability	Passed
Durability of operational reliability, humidity resistance	Passed

 0051	
Tyco Fire & Security GmbH Victor von Bruns-Strasse 21 8212 Neuhausen am Rheinfeld Switzerland 13 DoP-2015-4211 (FC500IP in FC501-L/FC501-H/FC501-HK)	
EN 54-21 Alarm transmission and fault warning routing equipment for fire alarm systems installed in buildings.	
EN 54-21 ESSENTIAL CHARACTERISTICS	
Performance of transmission	Passed
Operational reliability	Passed
Durability of operational reliability, Temperature resistance	Passed
Durability of operational reliability, Vibration resistance	Passed
Durability of operational reliability, Electrical stability	Passed
Durability of operational reliability, humidity resistance	Passed

The Declarations of Performance (DoP) can be found on the product webpage at www.fireclass.net.

TABLE of CONTENTS

INTRODUCTION	5		
FC501 Fire Control Panel	5		
<i>Accessory Items</i>	5		
Description	5		
<i>Input</i>	5		
<i>Outputs</i>	5		
<i>Operating Features</i>	6		
<i>Interface</i>	8		
<i>Access to Signalling and Commands</i>	8		
<i>Users and Installers Features</i>	9		
<i>Power Supply</i>	9		
Description of the FC500REP Repeater Signalling	10		
<i>FC500REP Repeater Control keys</i>	10		
<i>FC500REP Repeater LED description</i>	10		
Description of the Control keys (Panel)	11		
The status LED	12		
<hr/>			
PARTS IDENTIFICATION	13		
Description of Parts	14		
<hr/>			
INSTALLATION	17		
Installing the Control panel	17		
<i>Control panel closure</i>	17		
Installing FC500REP Repeater	19		
Description of the Terminals	19		
<i>Loop</i>	19		
<i>Telephone line</i>	19		
<i>Fire</i>	19		
<i>Fault</i>	20		
<i>Audio station</i>	20		
<i>Auxiliary outputs</i>	20		
<i>RS485</i>	21		
<i>Battery</i>	21		
The System Wiring	21		
<i>Connecting Addressable Devices</i>	21		
<i>Connecting Repeater FC500REP</i>	22		
<i>Connecting Output Devices</i>	24		
<i>Bell Outputs</i>	24		
Connecting the Power Supply	25		
<i>Thermal Probe</i>	26		
Installing FC500IP board	27		
Installing the 38Ah battery metal Box	28		
Maintenance	28		
<hr/>			
PC PROGRAMMING	31		
Installation	31		
Select language	31		
		Software window Look	31
		Control panel connections	31
		Main window	32
		<i>Icons</i>	32
		<i>File menu</i>	32
		<i>Tools menu</i>	33
		<i>Help Menu</i>	33
		Panel Details	33
		<i>Panel Details Menu</i>	33
		<i>Communication Menu</i>	34
		<i>Language Menu</i>	34
		<i>Firmware Update menu</i>	35
		<i>ScreenSaver menu</i>	35
		<i>Account Menu</i>	35
		Programming Pages	36
		Loop Devices programming	36
		<i>Description of the icons in the tool bar.</i>	36
		<i>Loop wiring Calculation</i>	37
		<i>Detectors parameters programming</i>	37
		<i>Input module parameters programming</i>	38
		<i>Output module parameters programming</i>	39
		<i>Multiple Input-Output Module - Parameters Programming (FC410MIO/FC410QIO)</i>	40
		<i>Manual Call Point parameters programming</i>	40
		Zones programming	41
		Outputs Programming	42
		<i>SC1, SC2 Outputs</i>	42
		<i>OC1, OC2 Outputs</i>	42
		<i>Relay Outputs</i>	43
		General Options programming	43
		General Output Settings	45
		<i>Panel Setting for Symphony Sounders and Panel setting for AV Base Sounder</i>	45
		Communicators Programming	45
		Clock	47
		Log	47
		Utilities	48
		<i>Battery Calculation</i>	48
		User mode	49
		<i>Graphic Maps</i>	50
		<i>Disable</i>	50
<hr/>			
		PROGRAMMING FROM THE PANEL	53
		Using the system	53
		Operating the system from the Panel	53
		<i>Alphanumeric entry (Editing text)</i>	53
		Assistant text composition	54
		<i>Single Selection</i>	54
		<i>Multiple Selection</i>	54
		<i>Date and Time</i>	54
		<i>Numeric entry</i>	54

FC501 Fire Control Panel

The FC501 Fire panel series has been designed and manufactured to the highest standards of quality and performance adopted by TYCO.

The FC501 Fire panel series is available in the following models:

- **FC501-L:** Analogue addressable Fire Control Panel with **3 Loops**, that can support up to **128** addressable device and 32 zones.

Powered: **BAW50T24** Switching Power Supply (1.8A @ 27,6V).

Suitable batteries: 2 * 12 V/ 7Ah
2 * 12 V/ 12Ah.

User Interface with Icons.

- **FC501-H:** Analogue addressable Fire Control Panel with **3 Loops**, that can support up to **128** addressable device and 32 zones.

Powered: **BAW75T24** Switching Power Supply (2.7A @ 27.6V).

Suitable batteries: 2 * 12 V/ 12Ah
2 * 12 V/ 38Ah

User Interface with LEDs descriptions in English.

- **FC501-HK:** Analogue addressable Fire Control Panel with **3 Loops**, that can support up to **128** addressable device and 32 zones.

Powered: **BAW75T24** Switching Power Supply (2.7 A @ 27.6V).

Suitable batteries: 2 * 12 V/ 12Ah
2 * 12 V/ 38Ah

User Interface with Icons.

 *In this manual the term FC501 is used to describe the characteristics common to all versions while the version name is used to describe the differences between the versions listed above*

 *The components of these Control panels operate as intended when the external ambient conditions comply with the requirements of class EN 60721-3-3:1995.*

The FC501 control panel has a 4-line, 40 characters per line LCD module with a backlight, which provides written information regarding the system status and for programming the control panel.

■ Accessory Items

FC500REP This Repeater panel is intended for connection (via 4 wires) to **FC501** Control panels. It provides all the visual and audible warnings generated by the Control panel and allows end-users to manage the system from a remote location (up to 1000 m, with double twist shielded cable).

The **FC501** Control panels can support up to 4 **FC500REP** Repeater panels.

FC500-MFI FC500-MFI is a Programmable Multi functional Module for connection of a real time event printer; furthermore, thanks to the terminal blocks, it is also possible to connect a “standard interface” to remotely control and manage a set of Inputs and Outputs to control the panel.

FC500IP Module to connect the control panel to a LAN (page 28).

FireClass Console This user-friendly software application (Microsoft Windows XP & above) offers a quick and easy way to program the Control panel and provides event log functions.

Description

■ Input

The 3 Loops manage up to 128 devices.

■ Outputs

This section describes how the Control panel outputs operate.

Supervised outputs The Control panel will be able to detect and signal short-circuits and power supply interruptions on this type of output.

Bypassable(Disabled) outputs The user will be able to disable (by means of the respective key) this type of output.

Silenceable outputs The user will be able to stop (via the **Silence/Resound Sounders** key)  this type of output.

The outputs can be silenced for an indefinite period (during Day Mode), or for the programmed Silence Time (during Night Mode).

■ Operating Features

Warning The FC501 control panel can be programmed to provide WARNINGS or Delay to Alarm status before ALARM status.

This status is signalled by the WARNING display. The panel generates a warning when an input point (detector) exceeds its warning threshold and there is risk of an alarm. A warning state is also generated by the input module, a useful feature to implement the system's supervision capability.

The **WARNING STATUS** is signalled by:



- control panel buzzer (2 seconds of sound at 440 Hz and then 2 seconds of pause).
- a WARNING message on LCD display.
- the WARNING output points if the **Delay to Alarm** option is enabled.



Delay to Alarm If a zone generates an alarm during Day Mode, the Control panel will start the Delay to Alarm Time. This status will be signalled by:

- control panel buzzer (0,5 seconds of sound at 880 Hz and then pause for 0,5 seconds).
- Blinking on the **Delay to Alarm** LED (for the first 8 zones only).
- Message ALARM+DLY on LCD display.
- Activation of respective outputs, if the **Delay to Alarm** option is enabled.

 *This Control panel generates an Instant Alarm if alarm conditions are detected during **Night Mode** or if an alarm is triggered from a Callpoint.*

During the Delay to Alarm status, the following actions can be taken (see Access to Signalling and Commands):

- **Access Level L1:** to activate an **Evacuation Alarm** by pressing and holding the **Evacuate** Key ,
- **Access Level L2:** to stop the Silenceable outputs and interrupt the Delay to Alarm Time by pressing the **Silence** key .

During **Silence** status (**Silence** LED glowing) , it is possible to use the **Silence** key to release the **Silenceable** outputs, or use the **Reset** key to restore standby status. .

 *If the Control panel is operating in Night Mode, the Control panel will exit from **Silence** status automatically when the programmed **Silence Time** expires.*

Alarm The Control panel generates an alarm when the **Delay to Alarm Time** expires. Alarm status will be signalled by:

- control panel buzzer (0,2 seconds of sound at 3300 Hz and then 0,2 seconds of pause).
- glowing of the Alarm LED .
- an alarm message on LCD display.
- activation of the **FIRE** and **SC1** outputs.
- activation of other outputs including SC2, OC1 or OC2 if programmed.

During the Alarm status, (see Access to Signalling and Commands) it is possible to:

- **Access Level 2** to stop the Silenceable outputs by pressing the **Silence** key. 
- **Access Level 2** to press the **Reset** key and Silence Buzzer.

During the **Silence** status (**Silence** LED glowing), it is possible to use the **Silence** key to release the **Silenceable** outputs. The **Reset** key restores the standby status.

 *If the Control panel is in Night Mode (**Day Mode** LED OFF), the Control panel exits **Silence** status when the programmed **Night mode Silence time** expires.*

Day/Night Mode The control panel can operate in DAY or NIGHT Mode. See the relevant section in the "PC PROGRAMMING" chapter.

If the system is silenced during DAY Mode, the SILENCE status will be held until the system is unsilenced unless new alarms occurs. If the system is silenced during NIGHT Mode, the SILENCE status is held until the Night Mode Silence time expires.

On power up (at default), the system is set to DAY Mode. During this operating mode, silenced alarms/faults are not unsilenced automatically until the Night Mode Silence time expires.

Fault This Control panel can detect and signal the Faults shown in the Table 1. Fault conditions are signalled by:

- the control panel buzzer (1 second of sound at 660 Hz and pause for 1 second).
- glowing on the **Fault** LED  and on relative Fault LED.
- a **Fault** message on LCD display.
- activation of the **Fault** output.
- activation of other outputs including **SC2**, **OC1** or **OC2** if programmed.

The **Fault** output and any additional programmed fault outputs (if correctly programmed by the Installer) will automatically restore to standby when fault conditions clear.

Under certain circumstances, fault conditions may clear spontaneously. If this occurs, the event will be stored in the memory until the Control panel is reset.

Stored Fault events will be signalled by slow blinking on the Fault LED. .

Silence This Control panel provides a **Silence** key which can be used to restore the Silenceable outputs to standby status.

The Silence status is signalled by glowing on the **Silence** LED .

The Silence status is held until one of the following occurs:

- The Silence key is pressed again 
- The programmed **Night mode Silence time** expires when the Control panel is operating in **Night Mode**
- A new Alarm condition is detected.

Message	Problem
Switching 1	<i>Switching power supply 1 Fault</i>
Mains fault	<i>The Control panel is NOT powered from the Mains</i>
Battery	<i>The Control panel batteries charger not working properly</i>
Low battery	<i>The Control panel batteries are empty</i>
Earth	<i>Leakage to Earth</i>
24A Output	<i>24A Output is shorted</i>
24R Output	<i>24R Output is shorted</i>
Flash writing	<i>Flash writing error</i>
Flash erasing	<i>LOG erasing error</i>
Main controller	<i>Main controller fault</i>
Firmware main contr.	<i>Checksum fault</i>
Prog.data main cont	<i>Data programming Checksum fault</i>
Prog.data tel.board	<i>Aux Controller data programming Checksum fault</i>
Loop Communication	<i>Communication Loop fault controller</i>
Not programmed dev	<i>Loop device without address</i>
Loop return open	<i>Loop negative signal open</i>
Loop signal open	<i>Loop positive signal open</i>
Loop local short	<i>Local short on Loop controller</i>
Loop right short	<i>Right side Loop short</i>
Loop left short	<i>Left side Loop short</i>
Non answer	<i>Loop device does not answer</i>
Dirty level	<i>(Smoke detector ONLY) the dirty threshold has been exceeded</i>
Short circuit	<i>Short circuit on Input module</i>
Open circuit	<i>Open circuit on Input module</i>
Power supply	<i>Main fault</i>
Wrong value	<i>A Loop device has a wrong value</i>
Stuck output	<i>An Output module relay is not switched</i>
Same address	<i>Several Loop devices have the same address</i>
Wrong Type	<i>Different loop device from that programmed in the panel</i>
IP Communicator	<i>The communication with IP controller is lost</i>
IP receiver	<i>The communication with IP receiver is lost</i>
Display communic.	<i>Communication fault on Display controller</i>
PSTN communicator	<i>The communication with PSTN controller is lost</i>
Telephone line	<i>Telephone Line fault</i>
LOG Full	<i>LOG fault</i>
Backup PSTN line	<i>Backup Telephone Line fault</i>
PSTN Action not Ack.	<i>A PSTN action has not been acknowledged</i>
SC x short	<i>SC x= (1 or 2) short circuit</i>
SC X open	<i>SC x (1 or 2) open terminal</i>
Transistor SC x	<i>Transistor SC x (1 or 2) fault</i>

Table 1 *Description of Faults.*

Message	Problem
LOOP x NOISY	The devices on the loop x (1, 2 or 3) do not communicate properly with the panel (Check the quality of wiring)
PERIODIC TEST D	The digital call for periodic test has failed
PERIODIC TEST V	The vocal call for periodic test has failed
REPEATER COMMUNIC.	A repeater on the RS485 does not respond
MFI x COMMUNIC.	(x from 1 to 4)
PRINTER x FAULT	(x from 1 to 4)
PRINTER x ABSENT	(x from 1 to 4)
MFI x SERIAL CHANN.	(x from 1 to 4)
MFI x RADIO LINK	(x from 1 to 4)
MFI x RADIO PATH	(x from 1 to 4)
MFI x INy SHORT	(x from 1 to 4; y from 1 to 5)
DEFAULT DATA	The fire panel resets to default data

Table 1 Description of Faults (Continued).

 The Silenceable outputs can only be manually silenced at access level 2 or 3.

Disabled This Control panel can disable: the devices on the Loop, SC2 Output, OC1 and OC2 outputs, the software zones, the RS485 network devices (FC500MFI).

DISABLED zones cannot generate alarms or warnings of any kind, and DISABLED outputs cannot be activated.

The Disabled status will be signalled by the glowing **Disabled** LED ().

 The DISABLE facility is only available at access level 2 or 3.

Reset Resetting the Control panel will restore the outputs to standby status, clear the memory, and interrupt the power supply to terminals 24R.

 The panel can only be Reset at access level 2 or 3.

■ Interface

Visual Signalling The system status is signalled on the Control panel LEDs as follows:

- **GREEN** indicates normal operating conditions.
- **AMBER** indicates specific operating modes (for example Day or Night mode), and/or Fault conditions.
- **RED** indicates Alarm conditions.

Memory The Control panel signals Fault events (FAULT LED blinking ) until the system Resets, even if the event clears in the meantime.

Audible Signalling The Buzzer signals the Control panel status as in table 2:

 When an alarm is silenced and a new fault is detected, the control panel will resound the previously silenced alarm.

Status	Sound	Pause	Frequency
SYSTEM FAULT (main processor fail)	2.5 s	2.8 s	1300 Hz
SYSTEM FAULT (Programming data corrupted)	1 s	1 s	660 Hz
Warning	2 s	2 s	440 Hz
Delay to Alarm	0,5 s	0,5 s	880 Hz
Alarm	0,2 s	0,2 s	3300 Hz
Fault	1 s	1 s	660 Hz

LAMP TEST () key allows ALL users to test the Control panel Buzzer and LEDs.

■ Access to Signalling and Commands

There are 4 access levels, in compliance with the Fire Safety Regulations in force.

Access Level1 (L1) Viewing: **ALL** persons can view the Control panel status (No Password requested).

Access Level 2 (L2) Operating the system (PIN Code entered): Password Code Users can operate the system (User level).

Access Level 3 (L3) Programming and Opening the Control Panel (Password Code entered)

Programming and Opening the Control panel: ONLY **Qualified persons with authorization** are allowed to open the Control panel door (requires removal of the Coverscrews) for maintenance purposes or to replace batteries. (Installer Level).

Access Level 4 Repairing or replacing the PCB: ONLY the **Manufacturer** should be allowed to repair or replace the PCB, (requires removal of the Cover screws).

■ Users and Installers Features

The panel can recognize and manage up to 8 different users and 2 different installers. At each login of any users the login event is logged with the ID of the user. At each login of any installer, the login event is logged with the ID of the installer. It also logs the return to access level 1 of the panel to indicate the end of the user or installer session.

The default passwords for the eight Users are as follows:

USER #1	11111
USER #2	22222
USER #3	33333
USER #4	44444
USER #5	55555
USER #6	66666
USER #7	77777
USER #8	88888

The default passwords for the two installers are as follows:

INSTALLER #1	00000
INSTALLER #2	99999.

By default, only the USER #1 works with its default password. The other users are not available and not enabled. The USER #1 may not be disabled or made unavailable.

By default only the INSTALLER #1 works with its default password. The other installers are not available and not enabled. The INSTALLER #1 may not be disabled or made unavailable.

Only the INSTALLER #1, via Fireclass Console or panel User Interface, can modify the availability and enabling the status of the USERS #2 to #8 and INSTALLER #2.

The INSTALLER #1, via Fireclass Console or panel User Interface, may modify the password value for the USERS #1 to #8 and INSTALLER #2.

 *Each Installer or each User can modify its own password.*

When the first password is entered via User Interface by INSTALLER #1 to a User/Installer, it will be declared as "available" and will be automatically enabled.

If the first installer loses the password, it is possible to enter a new password using the following procedure:

1. Remove the two screws (access level 4), open the fire panel after and remove the jumper J5 of the main board.
2. Access the installer menu page.

3. Access the programming page of the installer password and enter the new password,
4. The new password is stored as the current INSTALLER #1. The user interface will return to the MAIN page, indicating an activity of local programming, followed by a panel reset,
5. Replace the J5 jumper to restore the normal program menu page functionality (see Figure 39b).

■ Power Supply

The power supply system of the **FC501** Control panels complies with EN54-4.

All models are powered by the Mains:



- the **FC501-L** has Switching Power Supply which supplies up to 1.8 A at 27.6V.
- the **FC501-H** has Switching Power Supply which supplies up to 2.7 A at 27.6V.
- the **FC501-HK** has Switching Power Supply which supplies up to 2.7 A at 27.6V.

All models can house two 12V batteries which, when connected in series, will supply 24V to the Control panel and peripherals in the event of a blackout.

The **FC501-L** can house two 12V, 7Ah batteries (YUASA NP or 12V 12Ah FR model or similar — flame class UL94-V2 or higher).

 *If necessary, (full configured Loop or for particular requirements of the system) the FC501-H and FC501-HK control panel can be connected to two 12V, 38 Ah batteries in an external metal box (see Figure 14).*

This Control panel can detect, signal and store in memory the following power faults: shorted 24A or 24R outputs; Low battery, Battery fault or Battery disconnected

Battery trouble LED (), Ground fault **Earth LED** () and Mains failure **Power Supply Fault LED** ().

The “**Battery** or **Low Battery**” fault may be signalled with a delay up to 1 minute (see Table 3). The “**Mains**” (Amber) fault will be signalled when the programmed delay expires.

Description of the FC500REP Repeater Signalling

■ FC500REP Repeater Control keys

☞ **Test, Silence Buzzer and Evacuate** Control keys **ONLY** can be activated without password (access level L1). All other Control keys can be activated with a password (access level L2 and L3) (see table 4).

■ FC500REP Repeater LED description

In table 3, a description of the FC500REP Control keys is provided.

LEDs	DESCRIPTION
FIRE	Glowing indicates Alarm status. In the event of an Alarm, the Control panel will activate the unbypassed alarm outputs.
More Alarms	Glowing indicates more Alarm status.
Pre-Alarm	Blinking indicates Delay to Alarm status.
Communicator (Red)	Glowing indicates that the transmission was successful. Blinking indicates that the transmission is in progress. The control panel display will show the connection type: PSTN, GSM, or LAN network.
FAULT	Glowing indicates the presence of a Fault. The following LEDs or the screen on the display indicate the type of the Fault. Slow blinking indicates a fault event in memory (Reset turns OFF).
Logic Unit	Glowing indicates a blocked Control panel. IMPORTANT: Maintenance required. NOTE – When the Control panel is switched on for the first time, this LED will blink until a Reset is performed.
Lost Device	Glowing indicates that a Loop device has disappeared (missing address).
Communicator (Amber)	Glowing indicates that the Dialer has been disabled. Slow blinking indicates that the dialer has broken down.
(SC)Nac Fire Output	Glowing indicates that the SC FIRE Output is bypassable (disabled). Slow blinking indicates the presence of a Fault on the SC FIRE Output.
Earth	Glowing indicates a Voltage leakage to Earth. IMPORTANT: Check wiring insulation
Low Battery	Glowing indicates that batteries are empty or faulty. If this condition persists, the batteries will be unable to function as intended in the event of a blackout. IMPORTANT: New batteries required.
NO Battery	Glowing indicates that batteries are empty or disconnected. Check that the connections are correct.
MAINS (amber)	Glowing indicates Mains failure (110/230 V) or Switching Power supply fault. During this condition, the Control panel will be powered by the batteries.
Day mode	Glowing indicates that the Control panel is operating in Day Mode. OFF indicates that the Control panel is operating in Night Mode.
Disabled	Glowing indicates the Disabled status of any bypassable entity.
Silence	Glowing indicates that Silenceable outputs have been forced to standby by means of the SILENCE key. In Day Mode the Silence status will be held until the Silence key is pressed again. If the Control panel is operating in Night Mode, the Silence status will be held until the programmed Night mode Silence time expires, or until a new Alarm condition is detected.
Test	Glowing indicates Test conditions on at least one zone.
MAINS (Green)	OFF indicates Mains failure (110/230 V). IMPORTANT: Power must be restored before the batteries empty.

Table 3 Description of the status LEDs.

KEY	DESCRIPTION
Lamp/Buzz Test	<i>This key tests the buzzer and LEDs . If this key is pressed (when the Control panel is functioning as intended), all the LEDs will glow and the buzzer will emit a continuous beep.</i>
Silence	<i>This key restores the Silenceable outputs to standby status. Silence status will be held until the Silence key is pressed again in Day Mode, or if the Control panel is operating in Night Mode, until the Night mode Silence time expires or until a new Alarm/Trouble condition is detected.</i>
Investigate	<i>This key refreshes the “Delay to Alarm Time”. If this key is pressed during “Delay to Alarm”, the remaining Delay to Alarm time will be increased with the programmed "Recognition delay".</i>
Silence Buzzer	<i>This key silences the local buzzer of the control panel. The buzzer will operate every time a new event is activated.</i>
Reset	<i>This key resets the Fire detectors and restores all outputs to standby status (Supervised/Silenceable outputs, NON-Supervised/Non-Silenceable outputs and Alarm zone outputs).</i>
Evacuate	<i>This key activates the evacuation. If this key is pressed for over 2 seconds, the system will generate an alarm.</i>
F1, F2, F3, F4	<i>These are the Function keys of the Display. Their functions vary according to the different display screens.</i>

Table 4 Description of the repeater Control keys

Description of the Control keys (Panel)

 **Test, Silence Buzzer and Evacuate** Control keys **ONLY** can be activated without PIN (access level L1), all the others Control keys can be activated with PIN (access level L2 and L3).

Silence The **Silence** key is used to restore the Silenceable outputs to standby status. If the Control panel is operating in **Night Mode**, **Silence** remains active until the programmed **Night mode Silence time** expires, or in **Day Mode** until the **Silence** key is pressed again. In both modes, **Silence** is automatically cancelled whenever a new Alarm condition is detected.

Reset The Reset key is enabled only at Level L2 (PIN) as the fire panel returns to the Stand-by status after the

Alarm, Delay to Alarm, Warning and FAULT conditions stop. At the end of the **Reset time**, the system will reprocess any alarm, delay to alarm, warning or fault signal which is not cleared by RESET operations.

 When RESET is running, the command keys cannot be used.

 In the English User Interface version, the icons will not be present.

 The reset of the Fire Panel can also be carried out by any FC500REP repeaters connected to the Panel. It is necessary to use a PIN to access L2 or higher.

For the **Evacuate, Lamp/Buzz/Test, Investigate, Silence Buzzer** keys, see table 5.







KEY	DESCRIPTION
 SILENCE/ RESOUND SOUNDERS	<i>This key restores the Silenceable outputs and the Loop devices to standby status. Silence status hold until the Silence key is pressed again in Day Mode, or if the Control panel is operating in Night Mode, until the Night mode Silence time expires or until a new Alarm/Trouble condition is detected.</i>
 RESET	<i>This key resets the Fire detectors and restores all outputs to standby status.</i>
 INVESTIGATION DELAY	<i>This key refreshes the “Delay to Alarm Time”: If this key is pressed during “Delay to Alarm”, the remaining Delay to Alarm time is increased with the programmed "Investigation delay".</i>
 EVAC	<i>This key activates the evacuation. If this key is pressed, the system generates an alarm.</i>
 SILENCE BUZZER	<i>This key silences the local buzzer of the control panel. The buzzer will operate every time a new event is activated.</i>
 LAMP TEST	<i>This key tests the buzzer and LEDs. If this key is pressed (when the Control panel is functioning as intended), all LEDs glow and the buzzer emits a continuous beep.</i>

Table 5 Description of the control keys (Panel).

The status LED

LED and the **Day mode** LED (if the control panel is in Day mode) should be On (glowing) .

Table 6 describes how the Control panel LEDs operate. During standby status, ONLY the GREEN Mains















LED		DESCRIPTION
	FIRE (Red)	Glowing indicates Alarm status. In the event of an Alarm, the Control panel activates the unbypassed alarm outputs.
	GENERAL FAULT (Amber)	Glowing indicates the presence of a Fault. The following LEDs or the screen on the display indicates the type of Fault. Slow blinking indicates a fault event in memory (Reset turns OFF).
	SYSTEM FAULT (Amber)	Glowing indicates a blocked Control Panel. IMPORTANT: Maintenance required. Slow blinking indicates the Control Panel restart. Fast blinking indicates that the data panel programming is corrupted. NOTE – When the Control panel is switched on for the first time, this LED blinks until a Reset has been performed.
	FIRE SIGNAL FAULT (Amber)	Glowing indicates the communicator has been disabled. Slow blinking indicates that the communicator has broken down.
	POWER SUPPLY FAULT (Amber)	Glowing indicates Mains failure (110/230 V). Fast blinking indicates Switching Power supply fault. During this condition, the Control panel will be powered by the batteries.
	EARTH FAULT (Amber)	Glowing indicates a Voltage leakage to Earth. IMPORTANT: Check wiring insulation.
	BATTERY TROUBLE (Amber)	Glowing indicates that the batteries empty or faulty. If this condition persists, the batteries will be unable to function as intended in the event of blackout. IMPORTANT: New batteries are required.
	POWER ON (Green)	Glowing indicates that the panel is supplied with power. OFF indicates Mains failure (both mains & battery power is lost) (Battery disconnect threshold: 19,2 V). Power must be restored before the batteries reach the disconnect threshold.
	MORE INFO (Amber)	Glowing indicates that there is hidden information with lower priority. Access the page View List to show the hidden information. OFF indicates No hidden information is available.
	SOUNDERS SILENCED (Amber)	Glowing indicates that the Silenceable outputs and Loop device have been forced to standby by means of the SILENCE/RESOUND SOUNDERS key. In Day Mode, the Silence status will be held until the SILENCE/RESOUND SOUNDER key is pressed again. In Night Mode, the Silence status will be held until the Night mode Silence time expires or until a new Alarm/Trouble condition is detected.
	FIRE SIGNAL ON (Red)	Glowing indicates that the transmission was successful. Slow Blinking indicates that the transmission is in progress. On the control panel screen, the connection type: PSTN, GSM, or LAN network are displayed.
	SOUNDERS FAULTS/DIS	Glowing indicates that the SC1 Output is disabled or outputs configured to "act as SC1" are disabled. Slow blinking indicates that the SC1 is in fault or outputs configured to "act as SC1" are in fault. OFF indicates all the main sounder outputs (EN54-1, TYPE "C" outputs) function properly.
	DISABLED	Glowing indicates the Disabled status of any bypassable entity.
	TEST	Glowing indicates Test conditions on at least one zone.
	DAY MODE	Glowing indicates that the Control panel is operating in DAY MODE. OFF indicates that the Control panel is operating in NIGHT MODE.
1-8	SOFTWARE ZONES RED	Glowing indicates that the corresponding Software zones are in Alarm status . Slow Blinking indicates that the corresponding Software zones are in Delay to Alarm status .
N/D	CONTROLS ON (AMBER)	Glowing indicates that the Control Panel is at least at level 2 so the Silence/Resound Sounders, Reset and Investigation Delay Keys are enabled.

Table 6 Description of the status LEDs.

PARTS IDENTIFICATION

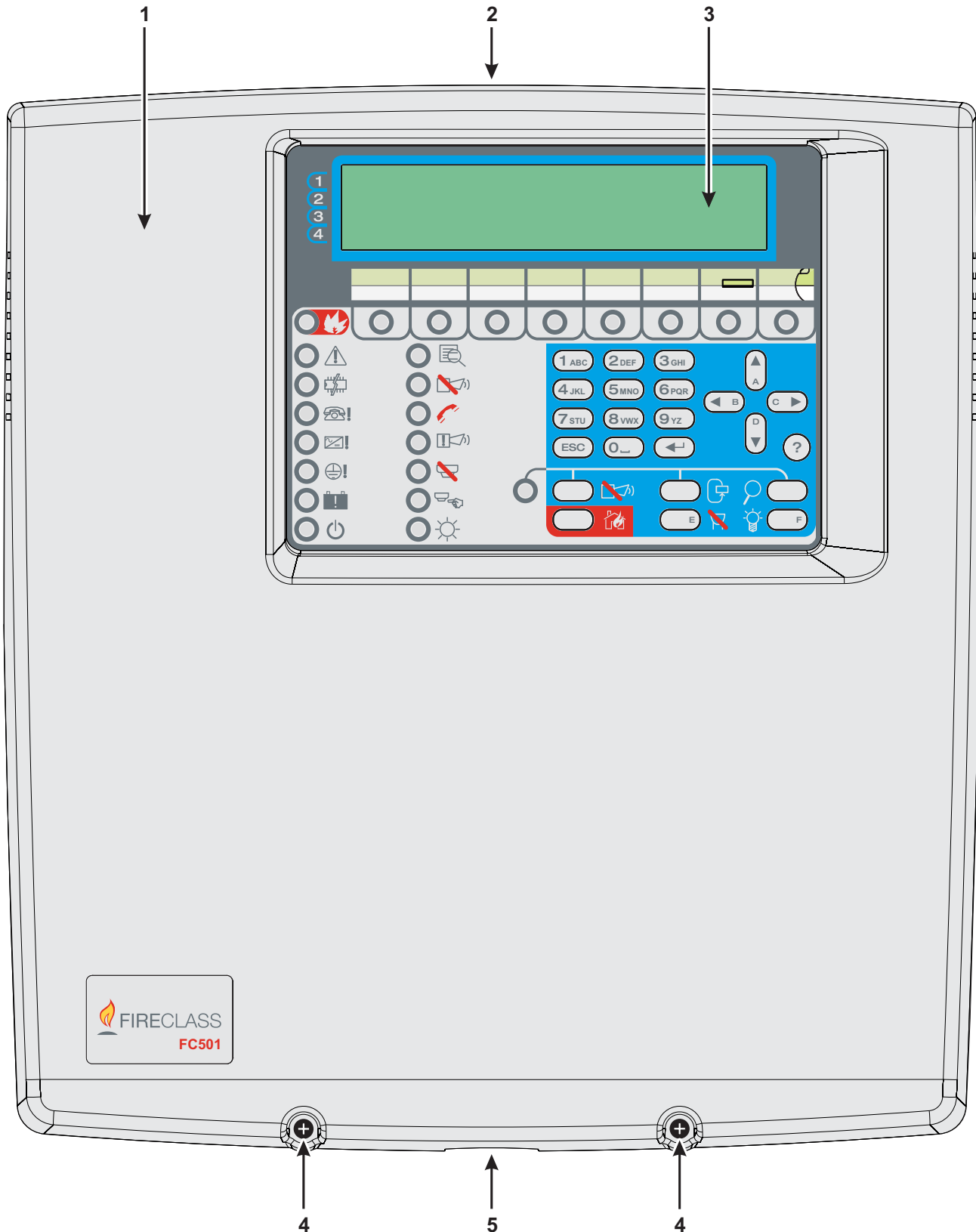

Figure 1 FC501 Parts: external view.

Description of Parts

This section describes the components of the FC501 Control panels.

Unless otherwise stated, the numbers in boldface in this Manual refer to the tables and diagrams in this section.

P.	Description
1	FC501 cover
2	Knockouts for cables ducted externally
3	Display
4	Screws (2) to close the Cover on Backplate
5	Knockout for connection FC501-H Panel with FC500BX battery cabinet (accessory item)
6	Hooks to secure the cover on the backplate
7	Backplate anchor screw locations

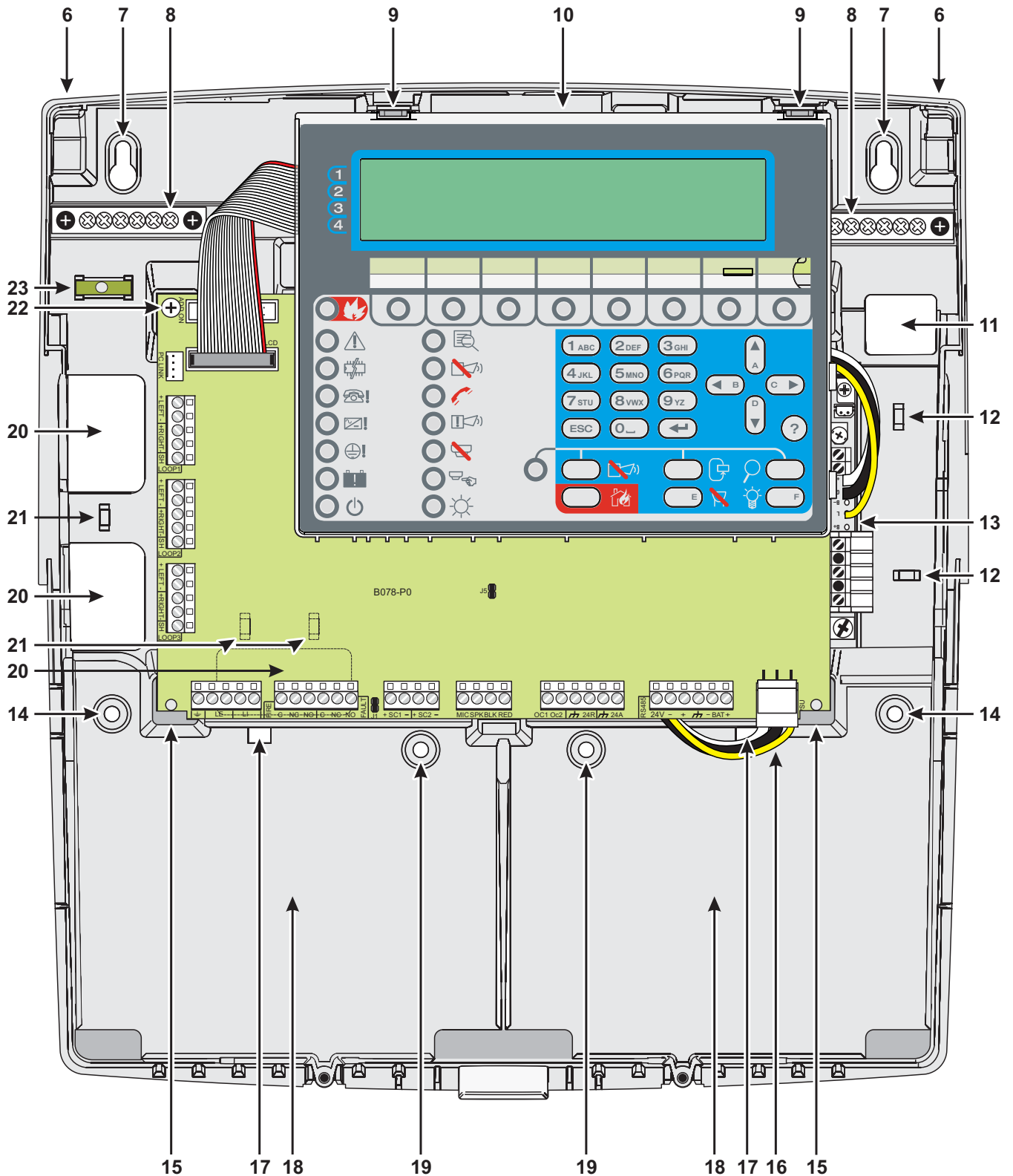



Figure 2 FC501 Parts: external view.

P.	Description
8	Terminals (2) for the earth connection wires
9	Hooks (2) to secure Main module on the backplate
10	Main Module (see figure 3)
11	Cable entry for channeled undertrack cables: power cable
12	Anchors (2) for power cable
13	Switching power supply (see figure 4)
14	Backplate anchor screw locations
15	Main module supports (2)
16	Power cable for Main module
17	Opening (2) to secure batteries
18	Location for 2 batteries 12V, 7Ah or 12Ah
19	Backplate auxiliary anchor screw locations (2)
20	Cable entry (3) for channeled undertrack cables
21	Cables anchor (3)
22	Screw to secure main module
23	Tubular spirit level
24	Connector for FC500IP Module
25	Opening to insert the zone location text strip
26	USB port

P.	Description
27	Power supply main module connector
28	RS485 Serial port & battery connection terminals
29	Programmable outputs and auxiliary power supply terminals
30	Buzzer (not visible)
31	Terminals for future use
32	Jumper J5 to reset the installer PIN n. 1 to the factory default (00000)
33	SC outputs
34	Jumper for the exclusion of the Earth Fault:  = Earth Fault detected (Default);  = Earth Fault ignored
35	FIRE and FAULT relay outputs
36	Terminals for phone line connection
37	Loop1
38	Loop2
39	Loop3
40	RS232 Serial (PC link)
41	Hole for Main module fixing

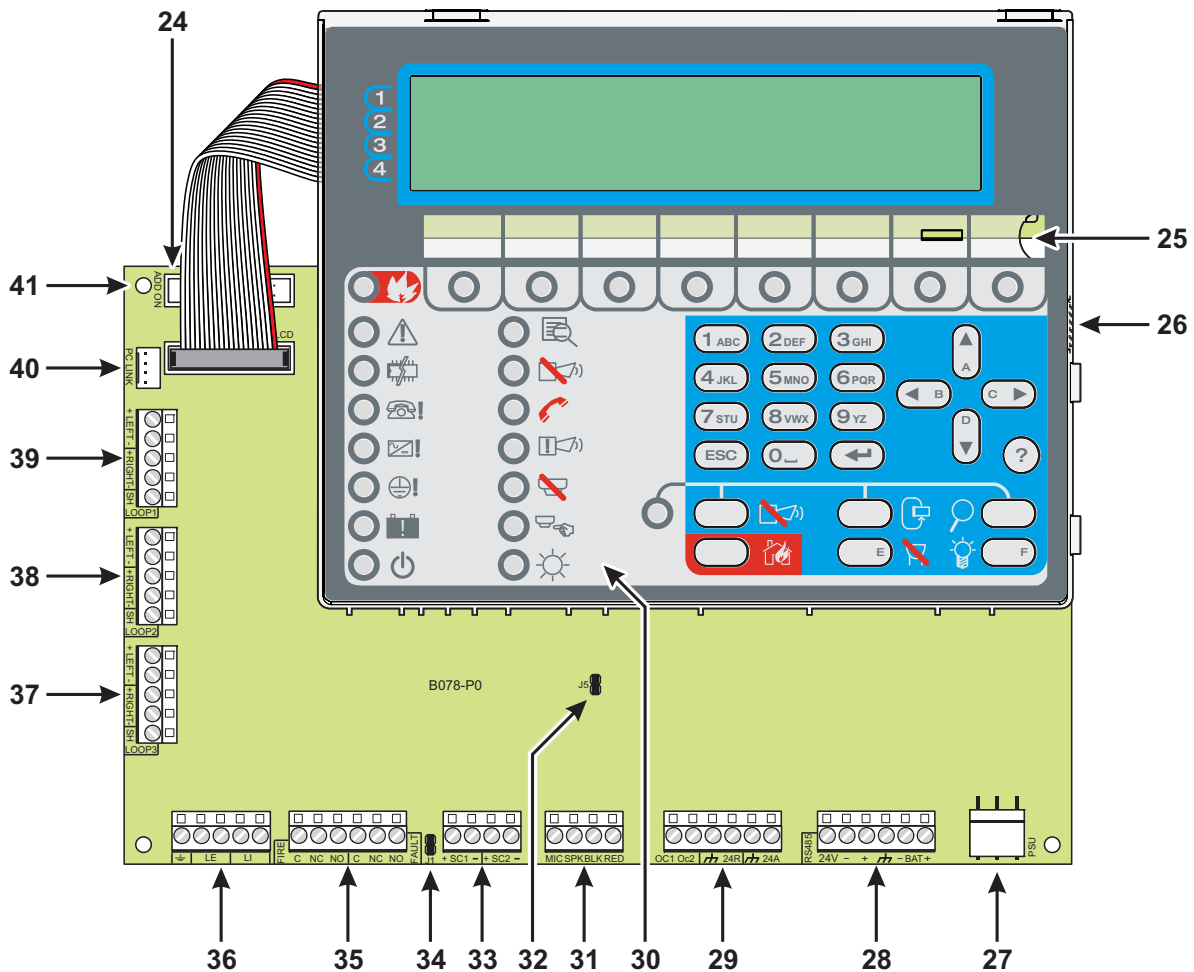

Figure 3 Main module Parts.

P.	Description
42	Protection Fuse
43	Main Power LED
44	Hole for switching Power supply fixing
45	Thermal probe connector
46	Fine trimmer for the Switching-power-supply output Voltage
47	Auxiliary power-supply terminals (27.6 V _{DC})
48	Mains power terminals (110/230V~60/50 Hz)
49	Switching-power-supply fixing screw
50	Cable for connecting Main Module
51	Protection Fuse
52	Switching-power-supply closure plastic rivet
53	Switching-power-supply anchor

*** NOTE (1)**

Before connecting the Fire control panel to PC for the PC programming phase, remove the jumper 34 of main board. When the programming phase is finished, replace the jumper otherwise the Earth fault (Leakage to Earth) will not be detected.

*** NOTE (2)**

To silence the buzzer permanently during installation, engage the control panel at Access Level 3 and remove the Jumper J5 32. If the buzzer is disabled, the panel User Interface does the following: the zonal LEDs slowly flash and "BUZZER OFF" string is displayed alternately with date and time. The timeout for the installer access is not changed as a result of this procedure. To reactivate the buzzer, replace the Jumper J5 when the installation process is complete.

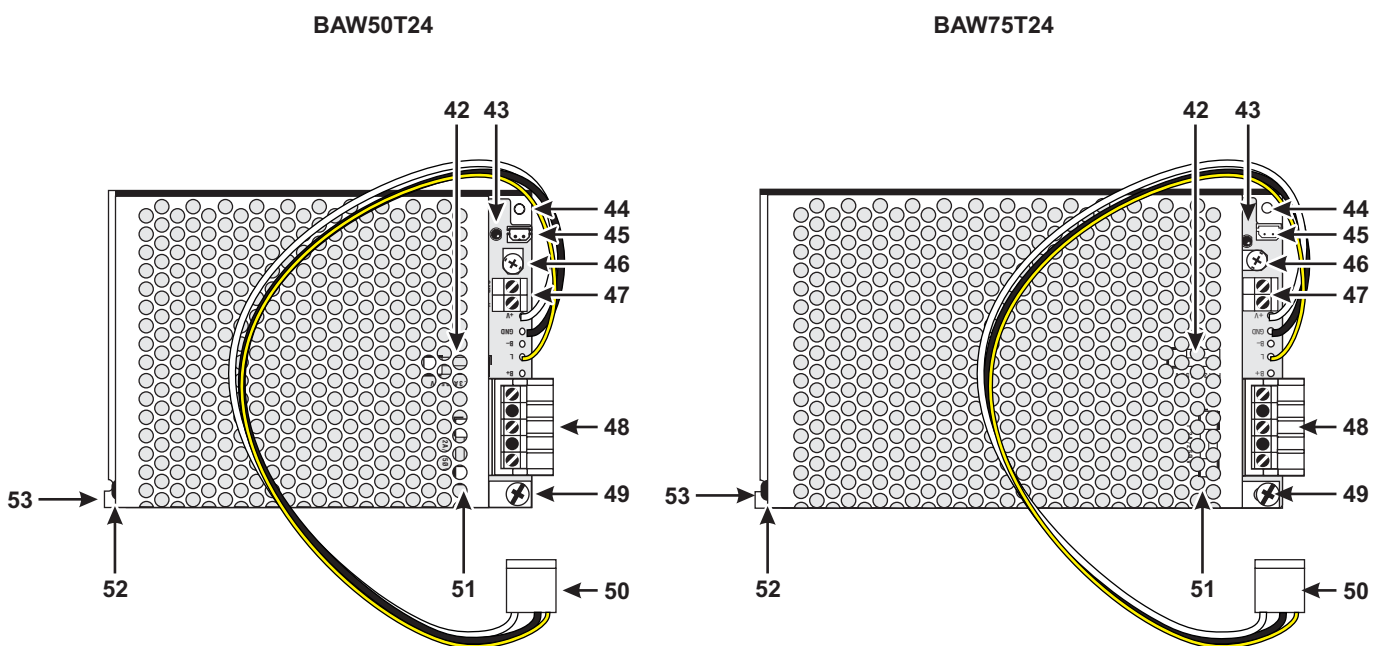



Figure 4 BAW50T24 and BAW75T24 Switching-power-supply.

 **Installation of this system must be carried out strictly in accordance with the instructions in this section, and in compliance with the local safety regulations in force.**

Prior to commencing the installation of the control panel, ensure that adequate precautions are taken to prevent damage to the sensitive electronic components on the display board and the control board due to electrostatic discharge. You should discharge any static electricity you may have accumulated by touching a convenient earthed object such as an unpainted copper radiator pipe. You should repeat the process at regular intervals during the installation process.

To install the fire panel, follow these steps:

➤ choose suitable mounting locations for the Control panel, detectors, fire warning and fire control devices.

 *The panel must be located in a clean, dry position, which is not subject to shock or vibration and at least 2 metres away from pager systems or any other radio transmitting equipment.*

➤ Lay the cables between the Control panel and the system peripherals.

 *Fire alarm cables must be separated from all other wiring that is not related to the fire alarm system.*

- If necessary, install any accessory modules.
- Carry out the necessary connections, leaving the power-supply connection until last.
- Program the Control panel in accordance with the instructions in the "PROGRAMMING" section.
- Test the entire system (Control panel, detectors, fire warning and fire control devices).

 *FC500IP module (Accessory Modules) should be installed before mounting the Control panel as described in the paragraph: FC500IP module Installation.*

 **Ensure that the Control panel power supply (Mains and Batteries) has been disconnected before installing any accessory Modules.**

Installing the Control panel

Work carefully through the following steps (see the Figures 1 and 2).

1. Remove the screws (4) and open the Control panel.
2. Drill the anchor screw holes 7 and 14.

 *Check for water pipes and electrical wiring before drilling.*

 *When using 12Ah batteries use mounting holes 19 to provide additional support.*

 *Use the Tubular spirit level (23) for leveling the Panel backplate.*

 **Check for water pipes and electrical wiring before drilling.**

3. If necessary, remove the surface conduit wire knockouts 2.

 *The cable conduit union with the cabinet must be secured by **HB Flame Class** (or higher) lock nuts.*

4. Pull the channeled undertrack cables through the cable entry 11 and 20 (for the power supply cable) then, using the anchor screws locations, secure the backplate to the wall.

 *Use anchors 12, (for the power supply cable) and 21 to secure the cables through the cable ties.*

■ Control panel closure

To close the panel:

1. Attach the cover to the hooks (6) and then rotate the cover down.
2. Use the screws (4) to secure the cover on the backplate.

LEDS AND KEYS LABELS

To insert the LED and Keys Labels (supplied) in the Repeater User Interface (see Figure below) work through the following steps:

- 1) Remove the screws 68 and open the Repeater FC500REP. Corresponding the A or B (in the overlay) insert the relevant LED and KEYS Labels.
- 3) Check that the labels are correctly inserted and then close the Repeater FC500REP.

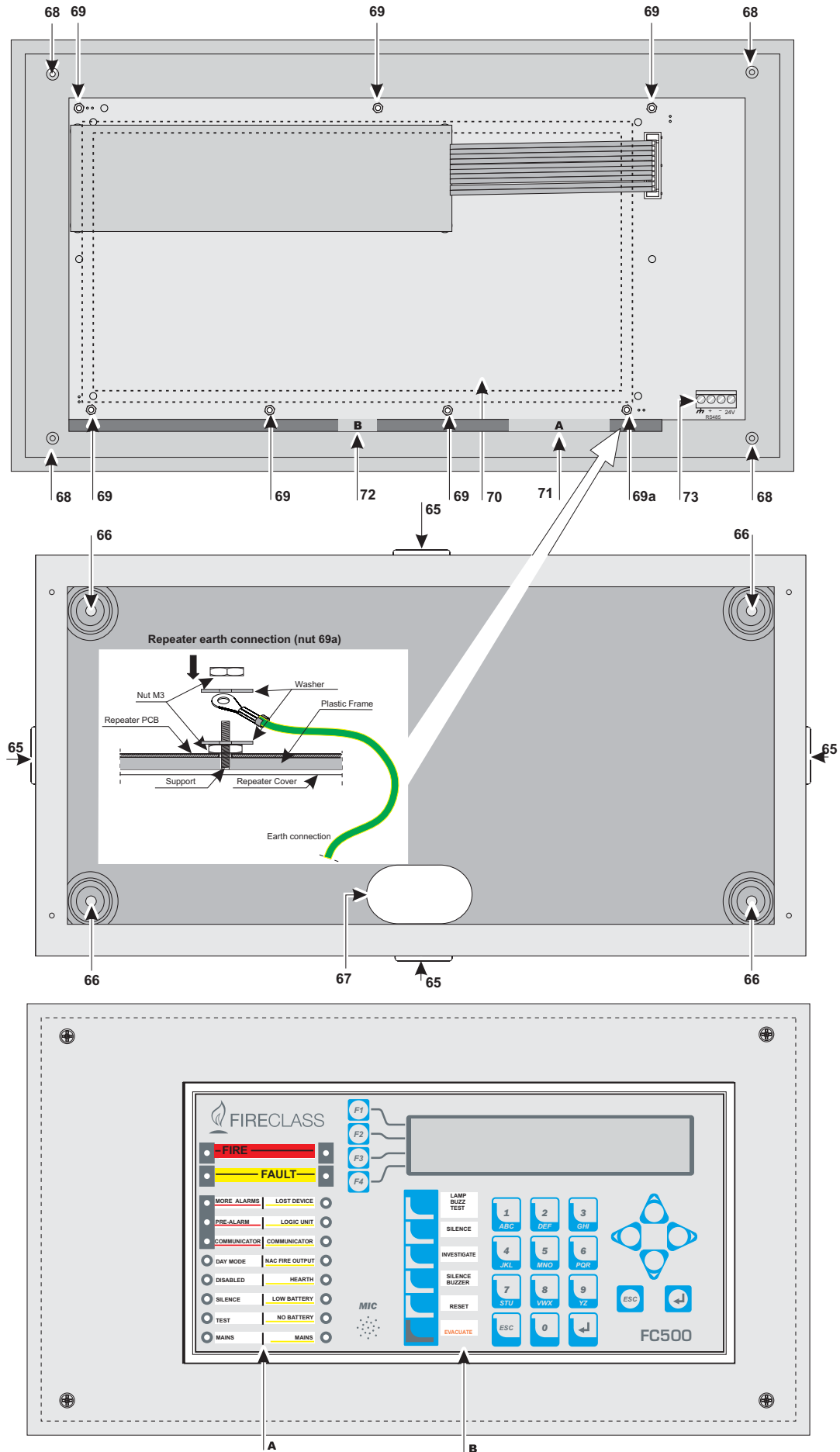

Figure 5 Installation FC500REP Repeater.

Installing FC500REP Repeater

Repeaters can be wall mounted, or flush mounted to an **ave® BL08** outlet box (or similar).

Follow these steps when installing an FC500REP Repeater:

1. Lay the connection cables (refer to “Connecting Repeaters”).
2. Remove the screws (**68**) (see Figure 5) and open the Repeater FC500REP.
3. If you are **flush mounting** the Repeater, go to step 4. If you are wall mounting the Repeater, drill the anchor screw holes (**66**).
4. Pull the wires through the wire entry (**67**), then, using the anchor screws, secure the Repeater to the wall.
5. Complete the connections to the terminal board **73** of the RS485 Interface, as described in the “Connecting Repeaters” section.
 - Connect the earth wire to the threaded support **69a** on the cover, as illustrated in Figure 5.

P.	Description
65	Knockouts for cables ducted externally
66	Holes for cabinet mounting
67	Cable entry for channeled undertrack cables
68	Screws to secure cover
69	Fixing nuts for User Interface on Cover
69_a	Repeater nuts for earth connection
70	User interface Repeater board
71	LED label slot
72	Key label slot
73	Connector for the Repeater RS485 interface

Description of the Terminals

This section describes the Control panel terminals.

■ Loop

LOOP1 Loop 1 terminals:

- +LEFT: Positive signal
- - LEFT: Negative signal (return).
- +RIGHT: Positive signal
- -RIGHT: Negative signal (return).
- -SH: Cable shield terminal.

LOOP2 Loop 2 terminals (as Loop1)

LOOP3 Loop 3 terminals (as Loop1)

 *The three loops of the panel can manage up to **128** addressable devices.*

 *The total length of the cables connected to the three loops must **NOT** exceed **2000 m**.*

 *The max current load for the three loops must not exceed **500 mA +25%**.*

■ Telephone line

LE Terminals for connecting the external telephone line.

LI Terminals for connecting the internal telephone line: connect these terminals to other telephone devices that need to share the same phone line as the fire panel.

 Terminal for connecting the earth wire.

■ Fire

[NC][NO][C] Non-supervised **fire** output. Dry contact relay for non-supervised devices.

It is activated, by default, at the entering of the panel in to the alarm status (first fire event).

The de-activation of the fire output is executed during the panel reset.

The fire output may be silenced (programmable option; default=NOT silenceable).

The fire output may be disabled.

The fire output may be programmed to works differently (only via FCConsole Software).

- During standby status, terminal **[C]** closes to terminal **[NC]**;

In the event of fire, terminal **[C]** closes to terminal **[NO]**.

 *EN54-2 certification applies **ONLY** when **FIRE** output is not C and/or J and/or G (EN 54-1) type. Therefore this output **MUST NOT BE UTILIZED** to manage Fire Alarm devices and/or Fire/Fault transmission devices and/or Automatic Fire alarm system.*

■ Fault

[NC][NO][C] Non-supervised **Fault** output. Dry contact relay for non-supervised devices. It is activated at:

- the entering of the panel in to the fault status (first fault event).
- in the case of Logic fault
- in the case of total loose of the power.

The de-activation of the fault output is executed during the panel reset.

The fault output may not be silenced.

The fault output may not be disabled.

The fault output may not be programmed to works differently.

- During standby status, terminal **[C]** closes to terminal **[NC]**;
- In the event of fault, terminal **[C]** closes to terminal **[NO]**.

👉 *EN54-2 certification applies ONLY when FAULT output is not J (EN 54-1) type. Therefore this output MUST NOT BE UTILIZED to manage Fault transmission devices.*

SC1 (Sounder Circuit) Supervised/Silenceable/Bypassable (Disabled) Bell output, for the Alarm signalling devices. Terminals for the connection of devices that are activated with the positive (24V) and must be supervised.

During standby status: negative pull-down to 0 V on [+] terminal; positive pull-up to 27.6 V on the [-] terminal. When control panel is in alarm status: positive pull-up to 27.6 V on the [+] terminal; negative pull-down to 0 V on the [-] terminal.

SC1 can be Silenced (forced to standby) by the menu command **DISABLE**.

👉 *This output is not programmable, it is activated every time the control panel goes into ALARM status.*

SC2 (Sounder Circuit) Supervised/Silenceable/Bypassable (Disabled), Programmable Bell output, for the Panel Alarm signalling or Panel Delay to Alarm or Panel Warning or Panel Fault or 1,2,3 or 4 Software zones(OR) Alarm, or 1,2,3 or 4 Software zones(OR) Delay to Alarm, or 1,2,3 or 4 Software zones(OR) Warning or 1,2,3 or 4 Software zones(OR) Fault or 1,2 or 3 Points(OR) Alarm or 1,2 or 3 Points(OR) Delay to Alarm or 1,2 or 3 Points(OR) Warning or 1,2 or 3 Points(OR) Fault.

During standby status: negative pull-down to 0 V on [+] terminal; positive pull-up to 27.6 V on the [-] terminal. When a programmed event occurs: positive pull-up to 27.6 V on the [+] terminal; negative pull-down to 0 V on the [-] terminal.

👉 *The SC1 and SC2 outputs can be forced to standby by resetting the control panel.*

The SC Outputs will hold standby status for the programmed Silence Time. If Alarm conditions are present when the programmed Silence Time expires for the SC1 or another programmed event for the SC2, they will re-activate.

👉 *SC1, SC2 accept devices that operate within SELV limits ONLY.*

👉 *The SC2 output, if programmed as SC1, will be of type C.*

👉 *If the 2-wire connection loop is used, the EN54-2 certification applies ONLY when the total number of devices (detectors, manual callpoints etc.) does not exceed 32.*

■ Audio station

MIC|SPK|BLK|RED Terminals for future use.

■ Auxiliary outputs

OC1-OC2 Silenceable, Bypassable (Disabled), NOT Supervised Outputs, programmable. These are open-collector terminals for the Panel Alarm signalling (Default) or Panel Delay to Alarm or Panel Warning or Panel Fault or 1,2,3 or 4 Software zones(OR) Alarm, or 1,2,3 or 4 Software zones(OR) Delay to Alarm, or 1,2,3 or 4 Software zones(OR) Warning or 1,2,3 or 4 Software zones(OR) Fault or 1,2 or 3 Points(OR) Alarm or 1,2 or 3 Points(OR) Delay to Alarm or 1,2 or 3 Points(OR) Warning or 1,2 or 3 Points(OR) Fault, which will be close to ground, when the connected event becomes active, and will remain in this state until the generating event has ended (so after a manual reset or a fault restore).

👉 *The output OC1 can also be programmed to signal the failure of the telephone line so as to be used in combination with a relay, for switching from the **primary phone line** to the **reserve line**.*

The OC1 and OC2 outputs can be forced to standby by resetting the control panel.

The OC1 and OC2 outputs will activate with a delay equal to the Delay to Alarm time when the programmed event occurs.

👉 *EN54-2 certification applies ONLY when OC1 and OC2 outputs are not C and/or J and/or G (EN 54-1) type. Therefore this output MUST NOT UTILIZED to manage Fire Alarm device and/or Fire/Fault transmission devices and/or Automatic Fire alarm system.*

24R [↗] Reset able auxiliary power supply to devices that operate at 24 V (**0.5A max**) (powered by the standby batteries):

- Positive (27.6 V) on terminal [24R];
- Negative on terminal [↗].

 This power supply is disconnected during the reset of the Control Panel (about 2 seconds) so it is suitable for devices that are restored when power supply is disconnected.

24A  Auxiliary Power supply to devices that operate at 24 V (**0.5A max**) always present and guaranteed by the batteries:

- Positive (27.6 V) on terminal [24A];
- Negative on terminal .

■ RS485

24V  Terminals for FC500REP repeater (maximum 4) and FC500MFI module (maximum 4) (0.5A max).

- Serial bus terminals [+] and [-];
- 27.6 V power voltage terminals  and [24V].

 The maximum cable run allowed is 1000m.

■ Battery

+BAT- Terminals to connect the batteries inside the FC501 control panel.

The System Wiring

 **High Voltage leads (110/230 V) must be bunched separately from Low Voltage leads (24 V). All leads must be bunched in such a way as to avoid contact with other wiring and components.**

■ Connecting Addressable Devices

The control panel has 3 loops for addressable analogue devices.

The maximum for all 3 loops is 128 addressable analogue fire detectors and analogue devices (Input modules, Output modules).

 Every detector and module connected to the loops must be assigned a unique address.

You can use 2 or 4 wires for the loop connections.

NOTE: The loop connection type must be specified during the programming phase.

Figure 7 illustrates the 2-wire connection to Loop1. Figure 6 illustrates the 4-wire connection to Loop2.

 Whatever the type of connection performed, make sure that any short circuit or open circuit in the wiring does not lead to the loss of more than 32 detectors. An isolator should be fitted at least every 32 detectors.

 If the connection is a 2-wire connection type, addressable analogue fire detectors and analogue devices (Input modules, Output modules) connect on the left.

 Use only shielded cable for all connections, with one end of the shield connected to the SH terminal of the Control panel and the other left free.

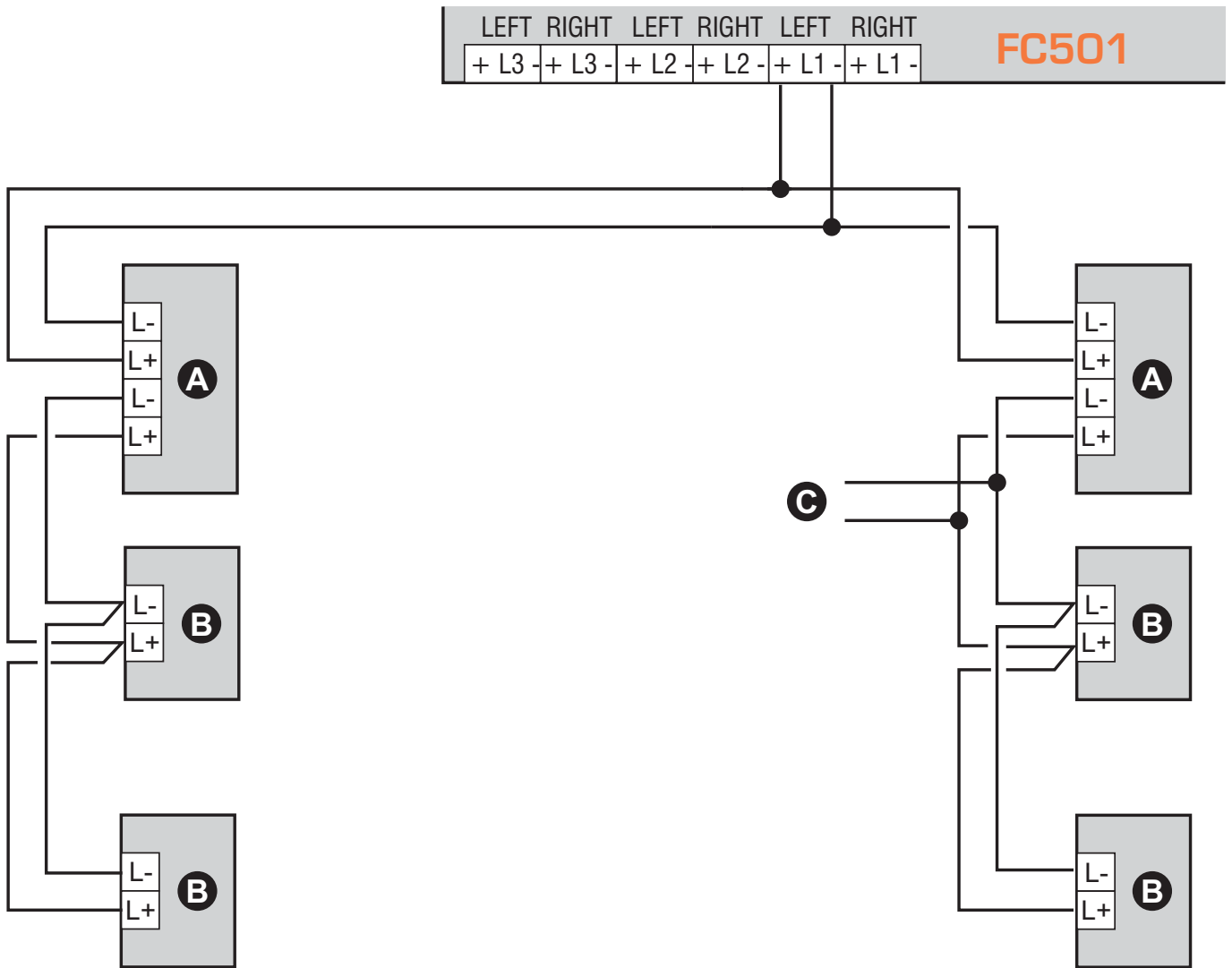

Figure 6 Wiring diagram of a 2-wire connection, a) Isolators; b) Compatible analogue devices (Fire detector, Input modules, Output modules, Manual callpoints); c) T connection.

■ Connecting Repeater FC500REP

An example of how to connect two FC500REP repeaters is displayed in Figure 8.

The RS485 port of the FC500 (terminals [↗], [+], [-] and [24V]) accepts up to 4 FC500REP repeaters;

Terminals [+] and [-] supply the power (27.6 V) to the repeater panels (see figure 8).

When a mains fault occurs, the Repeaters considerably decreases the absorbed power, switching off the LCD display backlighting (the LCD display backlighting switches on again, for 20 seconds when a key is pressed). But the absorption of the Repeaters connected to the control panel, will continue to run down the backup batteries, and decrease of the Stand-by supply time of the system.

As one control panel only is in the system, all the Repeaters must be supplied by the control panel itself, unless a Power supply Station is in the system.

 Use only shielded cable, with one end of the shield connected to the earth terminal of the Control panel and the other left free; the continuity, between several segments of connection must be secured.

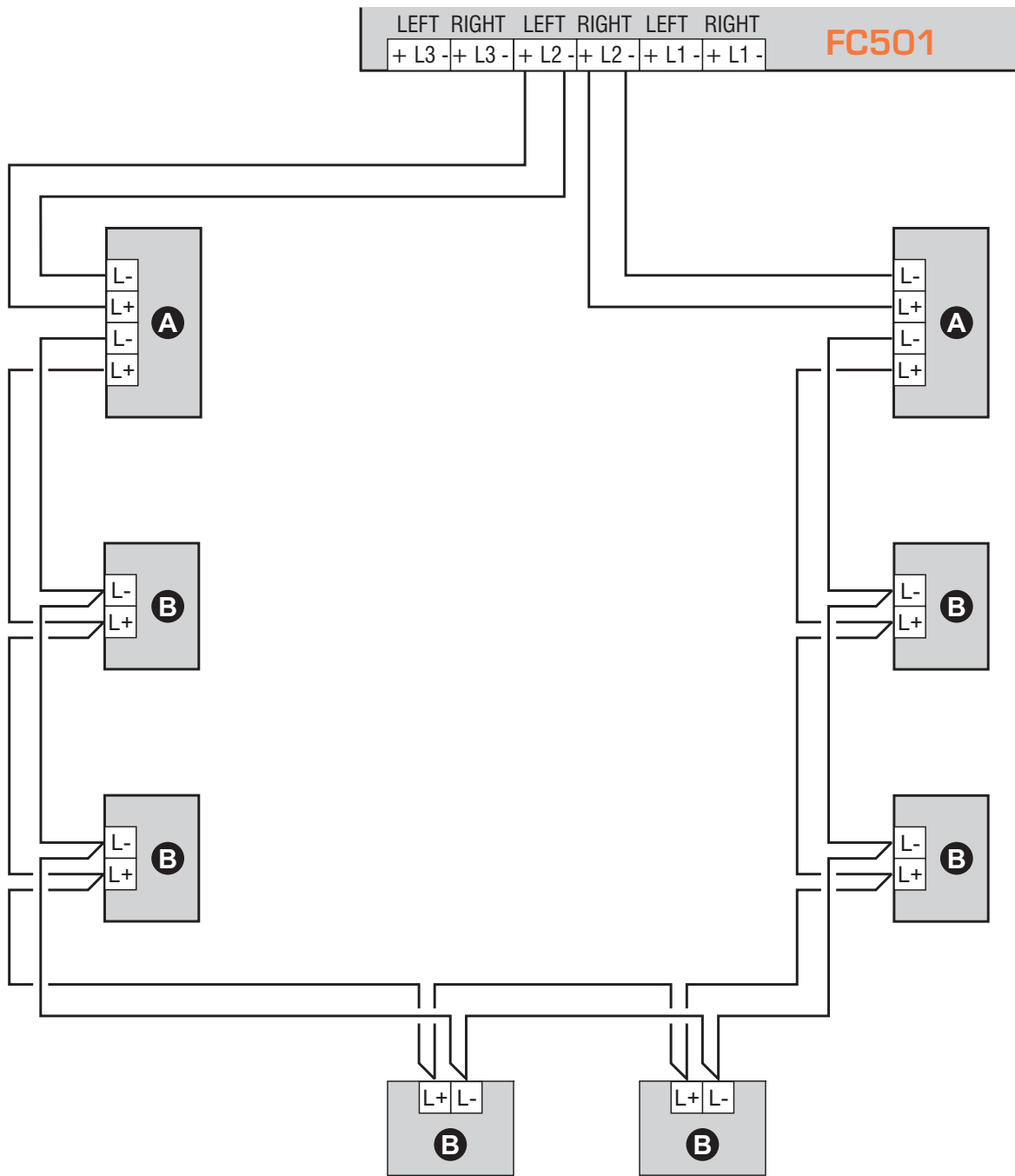

Figure 7 Wiring diagram of a 4-wire connection: **a**) Isolators; **b**) Compatible analogue devices (Fire detector, Input modules, Output modules, Manual callpoints).

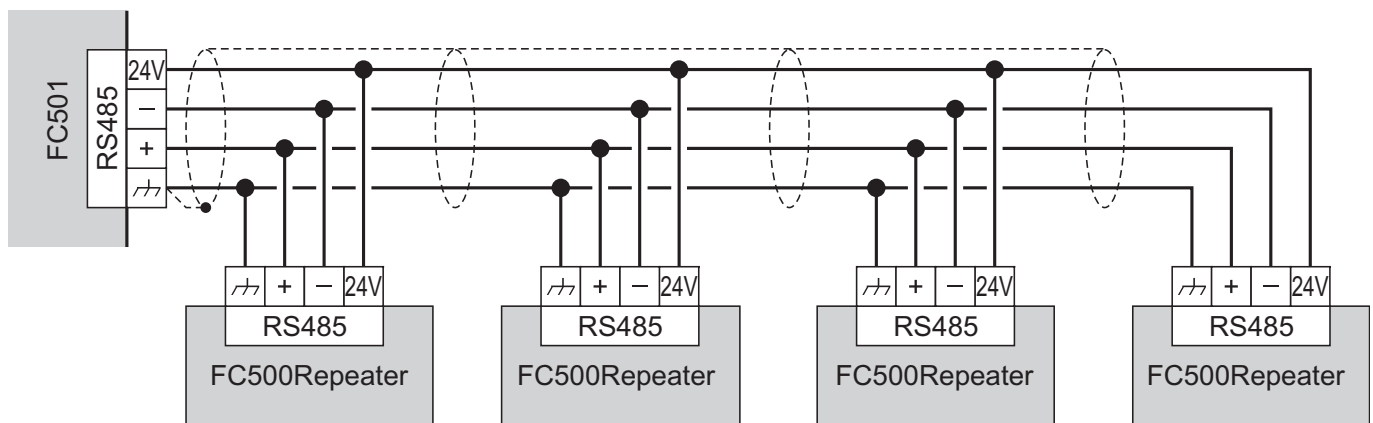

Figure 8 Wiring diagram of four (max) (FC500REP) Repeaters connected to the RS485.

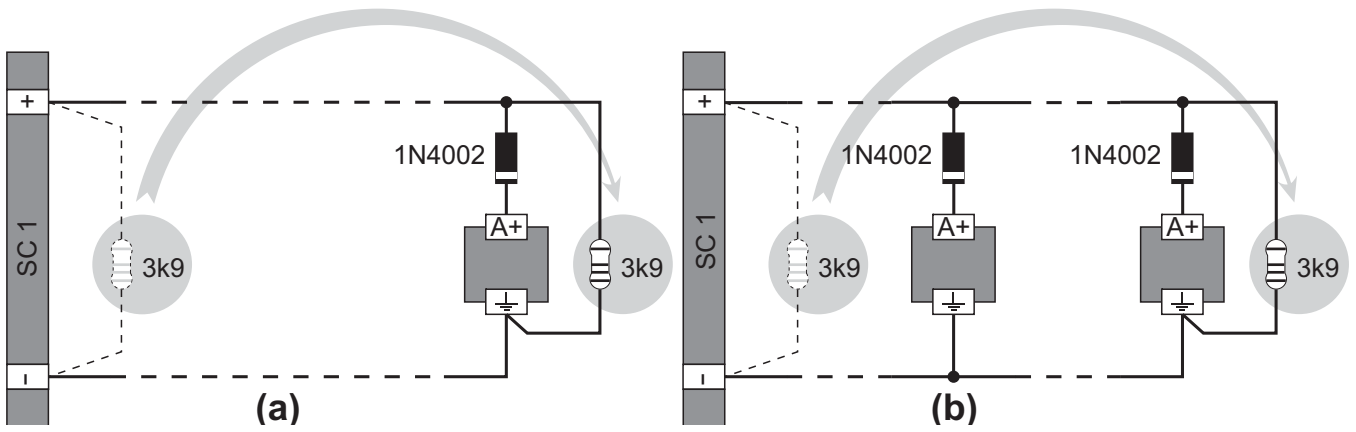

Figure 9 Wiring diagram of the connection of a single device (a) and several devices (b) to Bell outputs (device activated by positive (27.6 V) on terminal [A+]).

■ **Connecting Output Devices**

The control panel has NON supervised outputs and 2 Bell outputs.

Output devices can be connected to the loops by means of Output modules.

■ **Bell Outputs**

The Bell outputs are indicated by the letter SC and their address number.

👉 *The SC1, and SC2 Bell Outputs are Supervised, Silenceable, Bypassable (Disabled) SC2 also Programmable.*

The Bell outputs can be forced to standby status by the SILENCE button. Once an alarm has been acknowledged, you can silence the audible signalling devices and leave the visual signalling devices active until the alarm conditions cease.

For example, a connection similar to the wiring diagram in figure 10 will activate the Flasher, the Bell and the visual and audible signalling device of the Self-powered Siren in the event of an alarm.

Using the **SILENCE** button will stop the horn but not the flasher, which will continue to signal Alarm status until the RESET button is pressed.

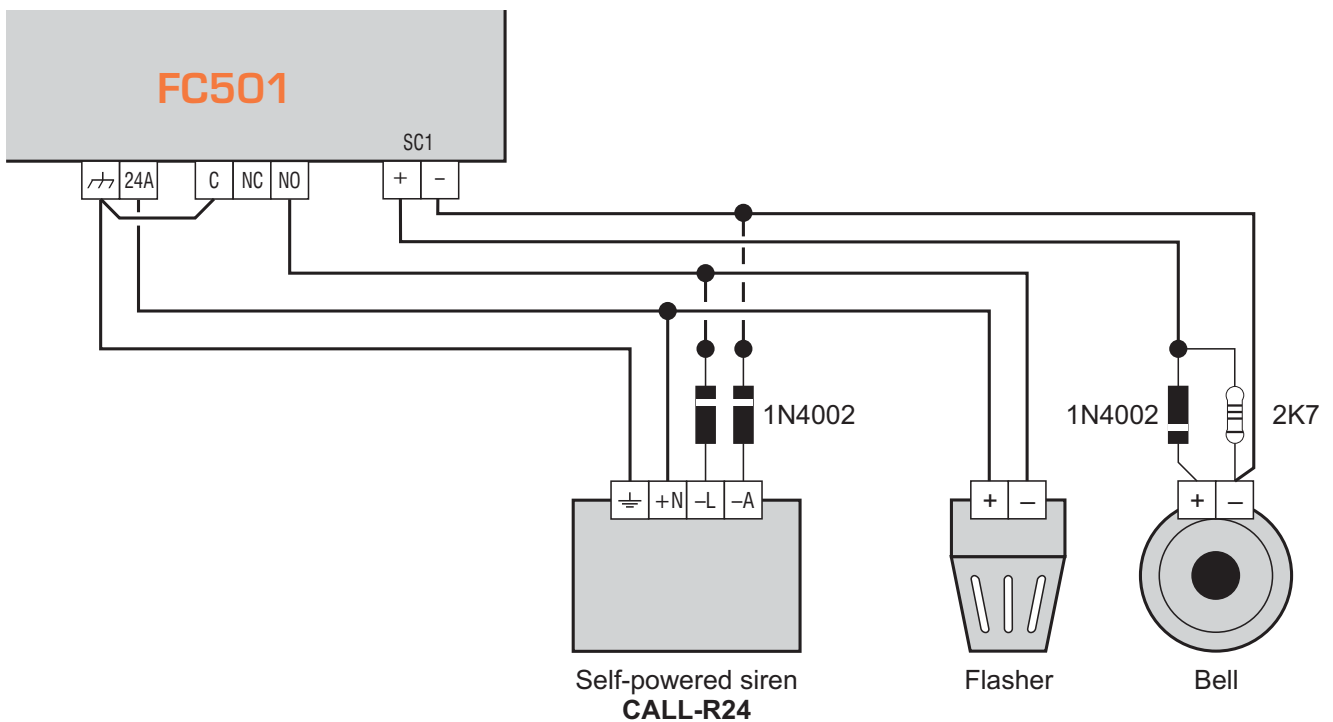



Figure 10 Wiring diagram: NON-silenceable and Silenceable Output connections.

Connecting the Power Supply

 The power circuits of this Control panel comply with the EN54-4 standard.

 In order to comply with the Safety regulations in force, the Mains must be equipped with a bipolar isolating device for protection against over voltage and short-circuit to Earth (e.g. automatic isolating switch).

This Control panel is powered from the Mains (110/230V~ 60/50 Hz) through a switching power supply, located inside the case. The **FC501-L** Control panel provides housing for two 12V, 7Ah or 12Ah maximum batteries; the **FC501-H** Control panel can be connected to two 12V, 12Ah or 38Ah in an external metal box (see Figure 14) for power during Mains failure.

The non-volatile memory will hold the programmed data at all times. In the event of MAIN failure, the AMBER Power Supply LED will turn ON.

The Control panel will check the batteries at all times, (refer to **Static Test** and **Dynamic Test**).

Static Test The **Static** Test monitors the battery charge during Mains failure. In the event of **Low battery** status (below 22.8 V), the **Low Battery** LED will turn ON. If this occurs, the Mains power must be restored before the batteries empty, otherwise, the system will shut-down.

Dynamic Test The **Dynamic** Test monitors the operating capacity of the batteries. In the event of a Failed Test result (batteries do not meet the Test requirements), the **No Battery** LED will turn ON. If this occurs, the backup battery must be replaced immediately, otherwise, the system will be unable to function in the event of Mains failure (blackout).

Follow these steps to connect the Mains Supply.

1. Locate the backup batteries in the housing (see Figure 2). Secure the batteries to the backplate of the panel, using the cable ties, in the appropriate opening.
2. Using the Jumper supplied, connect the batteries in series.
3. Observing the battery polarity, connect the battery terminals to terminals -BAT+ on Main Board (wires supplied).
4. **FC501-L** use 7 or 12Ah @ 12 V YUASA batteries; **FC501-H/FC501H-K** use 12 or 38Ah @ 12 V YUASA batteries or similar with case flame class UL94-V2 (or higher).
5. Connect the switching power supply with the 'external power supply (Main): connect the **Earth** wire to the [⊕] terminal on the mains terminal block **48**.
6. Connect the **Neutral** wire to terminal [N], and the **Live** wire to terminal [L] on the terminal board **48**.
7. Connect the connector 50 to the main Board connector 16.

 The Control panel will reset on power up.

 **DO NOT allow the power cable to cross over other wiring (see Figure 2). The power cable must be routed and held firmly in place by a two cable tie.**

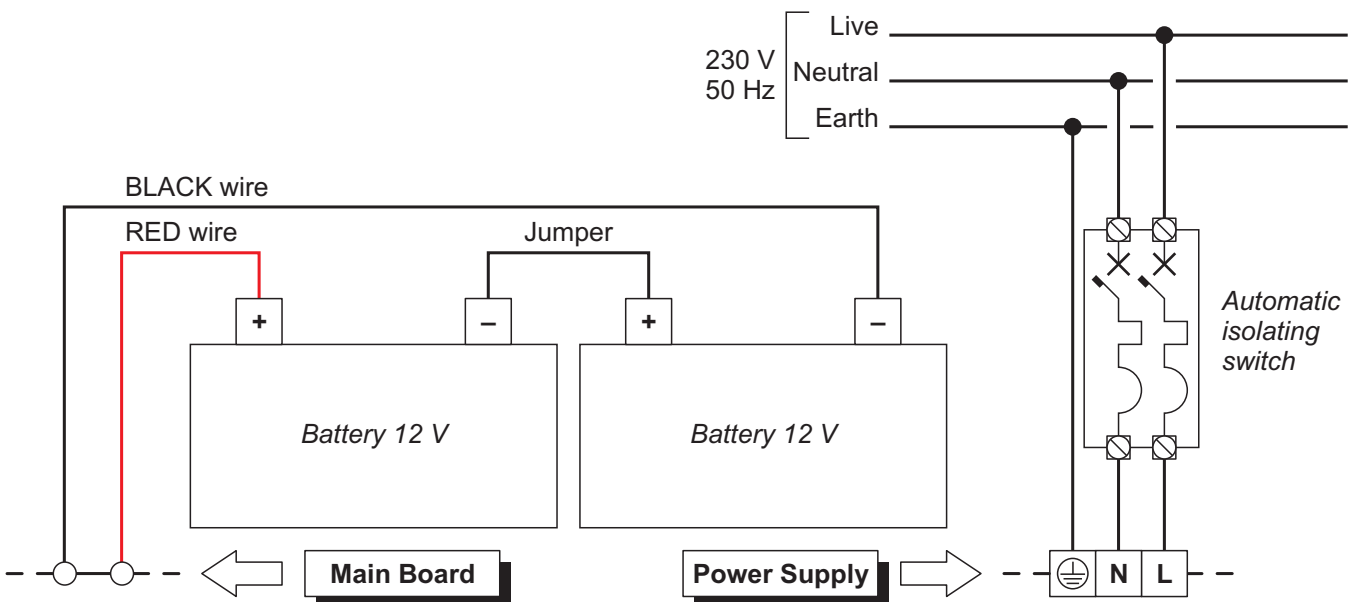

Figure 11 Wiring diagram for the power supply.

■ **Thermal Probe**

This Control panel supports the **KST** thermal probe. The probe will optimize the battery charging process by regulating the charge voltage in accordance with the battery temperature.

Work carefully through the following instructions (refer to figures 11 and 12):

1. Connect the probe **64** to the connector **45** on the switching Power supply.
2. Attach the probe to one of the batteries, in such a way as to obtain optimum heat transfer.
3. Measure the Probe temperature.
4. Using the graph in Figure 12 and/or Table 7, find the value (in accordance with the battery temperature) that the output voltage of the Switching Power Supply will be based on.
5. Disconnect the batteries and turn on the panel.
6. Using the trimmer 46, adjust the voltage on the voltage on the terminal board 47 to the required value.

7. Connect the batteries to the main board

⚠ Before removing the probe, disconnect the battery from the main board. Removing the thermal probe will cause the Switching Power Supply output voltage to rise to 29V or greater. This will overcharge or damage the battery. Once the battery is disconnected and if it is required to work without the thermal probe (EN54 approval will be lost), adjust the Switching Power Supply output voltage, using the trimmer 46, to 27.6Vdc. Reconnect the batteries only if their voltage is equal to or less than 27.6Vdc.

👉 To verify the battery efficiency, the charger circuit will measure the internal resistance of the batteries. In order for this measure is not distorted, you should use only the cables supplied; cables that are longer and/or have an insufficient section may erroneously simulate the condition of an inefficient battery.

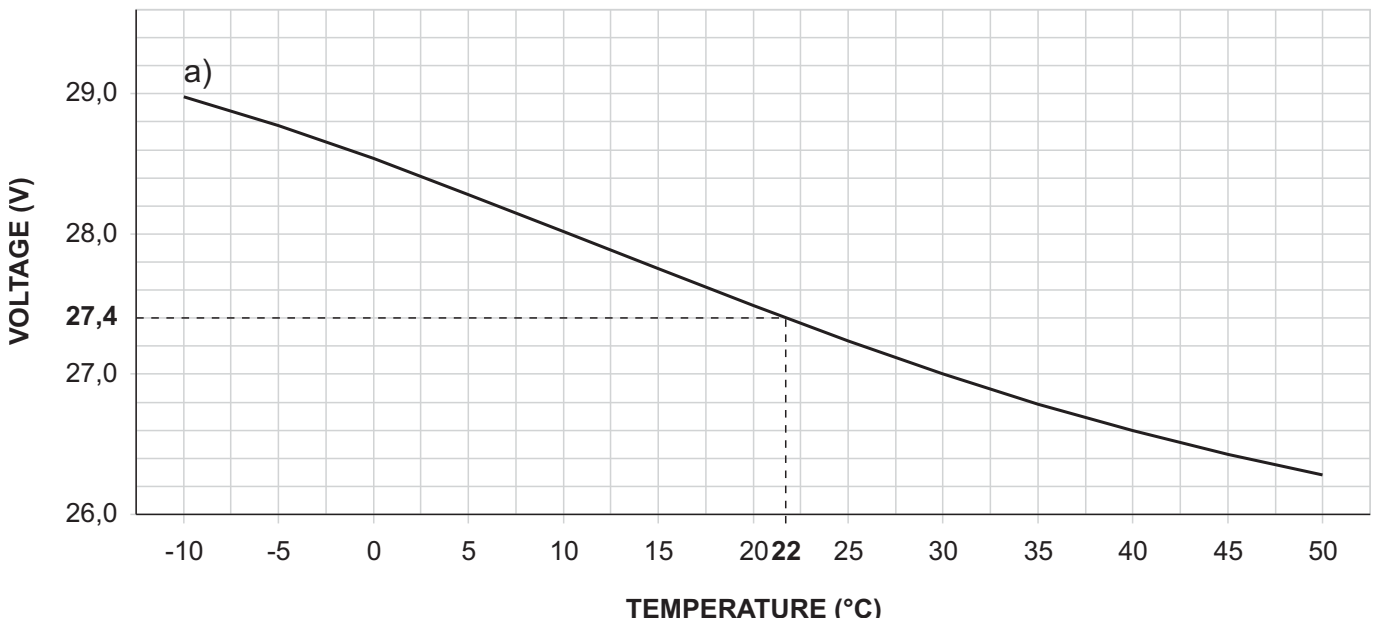

Figure 12 Switching Power Supply Output Voltage graph. To find the Output Voltage using the graph: — indicate the Probe temperature on the **TEMPERATURE (°C)** axis; draw a line from the temperature value point up to the curve **a)**; draw a line from the intersection point across to the **VOLTAGE (V)** axis; adjust the Output Voltage of the Switching Power Supply to the resultant value. For example, if the Probe temperature is 22 °C, the Output Voltage of the Switching Power Supply must be set at 27.4 V.

TEMPERATURE (°C)	-10	-5	0	5	10	15	20	25	30	35	40	45	50
VOLTAGE (V)	29,0	28,8	28,6	28,2	28,0	27,8	27,6	27,2	27,0	26,8	26,6	26,4	26,2

Table 7 Switching Power Supply Output Voltage chart. To find the Output Voltage using the chart: — select the nearest value to the Probe temperature on the **TEMPERATURE (°C)** row; read the respective value on the **VOLTAGE (V)** row; adjust the Output Voltage of the Switching Power Supply to the indicated value. For example, if the Probe temperature is 22 °C, the Output Voltage of the Switching Power Supply must be set at 27.4 V.

Installing FC500IP board

The IP Module should be installed into the base of the control Panel, as illustrated in Figure 13. Follow these instructions to install the FC500IP board:

⚠ Before installing the FC500IP Module, disconnect control panel from its power supply (mains and the batteries).

1. Open the control panel by unscrewing the two screws 4, then lift the cover from the bottom to separate it from the backplate. Remove the fastening screw, figure 2, item 22, between the motherboard and the backplate and unlock the support of motherboard + User Interface, figure 2, item 9, using a flat screwdriver. Lift the control board & display from the base.
2. Fix the IP Module on the base of the control panel using the supplied screws 56.

⚠ The IP Module must be connected to the earth of the electricity supply system.

3. Connect the cable 56a between the screws 56 and 56b.

⚠ The eyelet of the cable 56a must be inserted between the fixing bracket of the module and the screw 56.

⚠ Do not remove the wiring already present on the screw 56b.

4. Connect the connector 58 of the IP Module to the connector 55b of the control panel using the supplied flat cable 55. If you need to manage the control panel ONLY/ALSO via IP, connect the connector 57a of the IP module to the connector 55a of the control panel via the supplied PC-Link cable 55c.

5. Connect connector 59 to the LAN using an Ethernet cable.

👉 Use a category 5 (or better) shielded Ethernet cable (STP or FTP).

6. Re-fit the control board & display and secure with the screw.

7. Reconnect the control panel to the power supply.

8. Program the IP Module as described in the section "PC Programming". For further information, please refer to the dedicated manuals.

👉 See "To connect the control panel to a PC remotely".

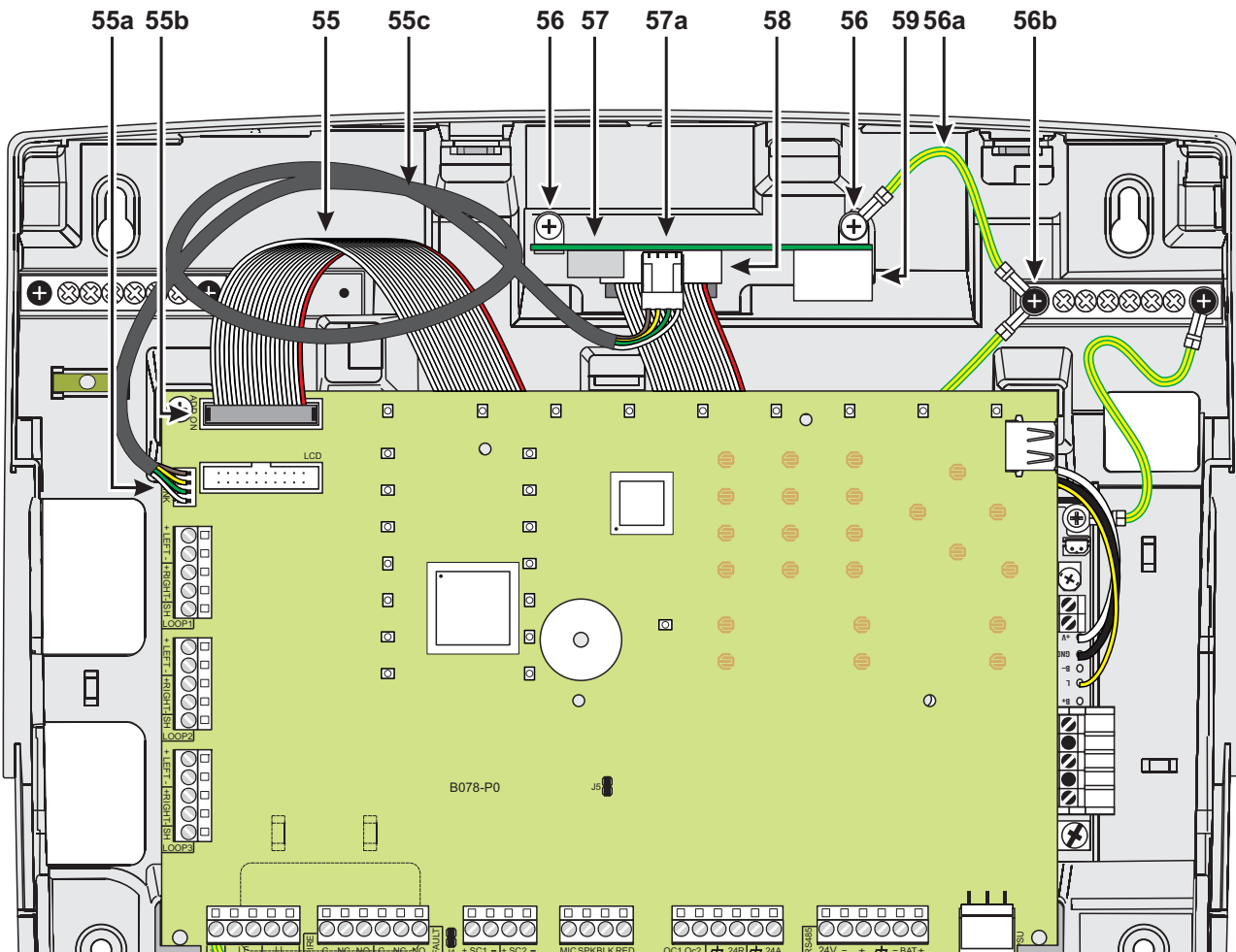



Figure 13 FC501 connection with the FC500IP.

Installing the 38Ah battery metal Box

Work carefully through the following steps (see Figure 14), for the FC501-H/FC501-HK fire panel only.

1. Remove the two screws on the cover and open the metal box.
2. Drill the anchor screw holes **64**.

 **Check for water pipes and electrical wiring before drilling.**

3. If necessary, using a hammer or similar tool, remove the surface conduit wire knockouts of the metal Box.
4. Secure the metal base to the wall.

 *The cable conduit union with the cabinet must be secured by **HB Flame Class** (or higher) lock nuts (see particular in Figure 14).*

5. Pull the wires through the cable entry and connect them (see Figure 14). See paragraph: "Connecting the power supply".

P.	Description
54	Thermal probe (see Fig.11 and12)
55	Flat cable for the connection with FC500IP
55a	Serial port RS 232 (PC LINK)
55b	Module IP (FC500IP) connector
55c	PC Link cable
56	FC500IP fixing screws
56a	Cable for earth wiring of the FC500IP
57	FC500IP board
57a	PC Link connector
58	Flat cable connector
59	Ethernet connector
60	38Ah Batteries cabinet (Accessory item)
61	Connecting Threaded tube
62	Nuts on Control Panel Backplate (FC501-H and FC501-HK only)
63	Nuts on 38Ah Batteries Backplate (FC501-H /FC501-HK)
64	Holes for cabinet mounting

Maintenance

To ensure that the system operates normally, it must be maintained with regular testing by the user and periodic maintenance by the installer in accordance with local laws.

 *For the maintenance of other devices such as detectors, modules etc., follow the dedicated instructions for the devices.*

The following operations must be carried out regularly:

A Using a damp cloth (DO NOT USE SOLVENTS OF ANY KIND), remove dust from the Control panel cabinet.

B Using the **Lamp Test** key, check that the LEDs and buzzer are functioning properly.

C Ensure that the batteries are sufficiently charged and functioning properly. If not, replace them immediately.

D Ensure that all cables and connections are intact.

E Ensure that there are no unrelated objects inside the Control panel case.

F Ensure that the control panel is capable of processing a fire alarm and operating the relevant sounders and/or outputs in consequence of this alarm. If there is a facility for transmission of fire alarm signals to a Central Station, ensure that the signal is correctly received.

G Verify the actual functionality of the circuit for the detection of earth fault. The procedure is as follows: connect one of the SH terminals of the loop to the ground:

➤ verify that the fault is reported correctly by the Fire Panel.

➤ remove the connection previously made.

Points **A** and **B** may be carried out by users.

Points **C**, **D**, **E**, **F** and **G** must be carried out by qualified persons only.

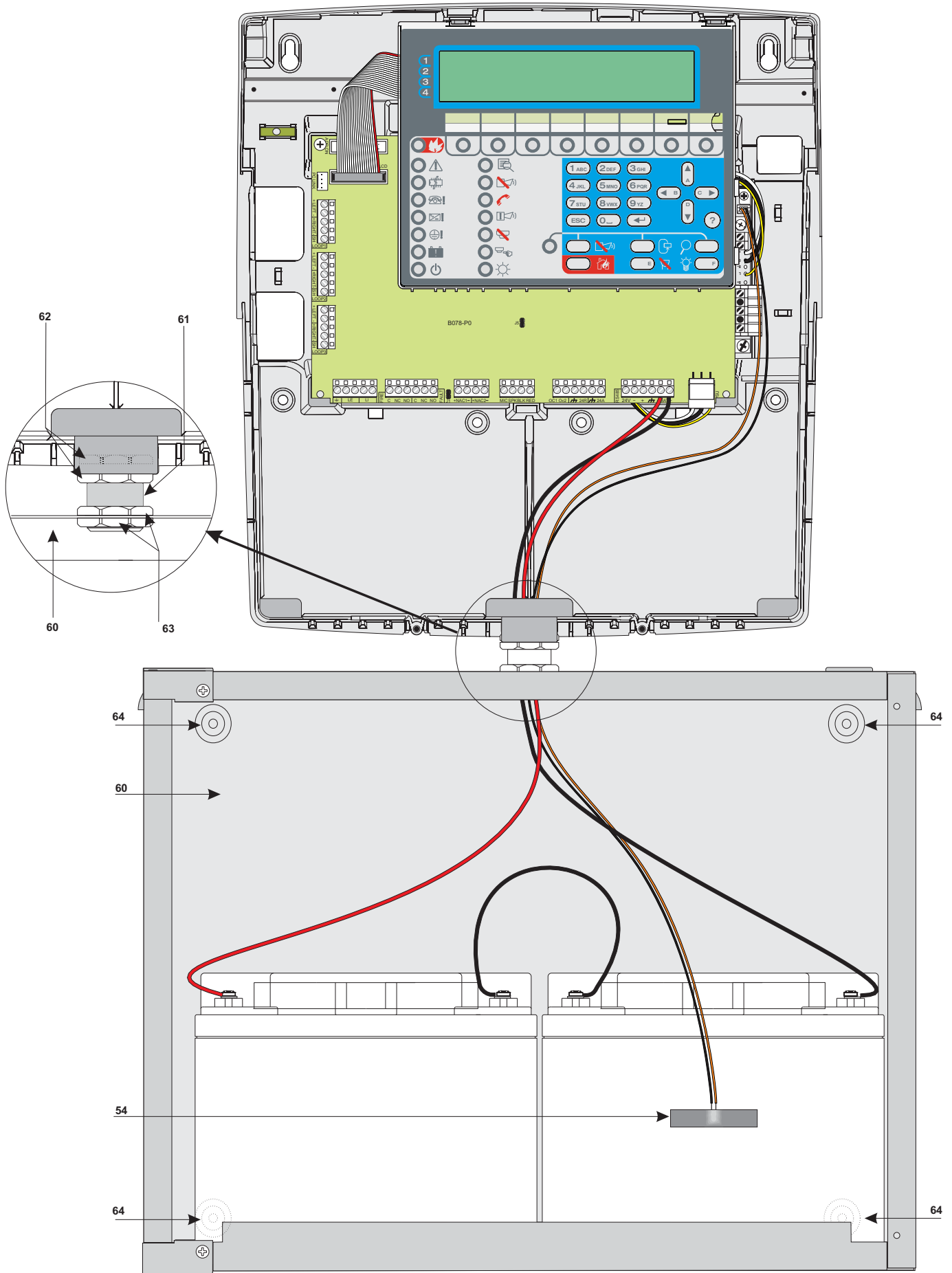



Figure 14 Control Panel (FC501-H/FC501-HK) and 38Ah Batteries metal Box connection (accessory item).

The system can be programmed from the Control panel (User Interface) or from a computer, using the **FireClass Console**. This section describes how to program the system from a computer. If you intend programming the system from the Control panel refer to the "PROGRAMMING FROM THE PANEL" section. To manage and program the FC501 control panel using a PC, the **FireClass Console** application must be installed on the PC.

Installation

Complete the following steps to install the **FireClass console** application:

- Run the installer program FCConsole-v1.xx.x.x-Setup.exe (.xx.x.x indicates the program version).
- Follow the required steps.

 *The latest version of the installer program can be downloaded from the FireClass website.*

 *When the FireClass Console starts for the first time, it will prompt you to select a country. Select and press the check button to confirm.*

Select language

You can select the language of the FireClass Console from the languages provided.

To Select the application language:

1. Run the **FireClass Console** application.
2. Select **Tools** from the **Main** window.
3. Select **Language** from the drop-down menu to open a window with the language list.
4. Select a language from the **Language** list.

Software window Look

To modify the look of the FireClass Console window, select **Tools** from the **Main** window and select "Skin". This option allows you to modify the look of the window.

Control panel connections

When using the Supervisory, Management, Downloading and Log Management functions, the control panel must be connected to your PC in local communication (RS232/USB) or remote by PSTN line, GPRS or LAN.

- Connecting the control panel in local: connect the PCLINK connector of the control panel (see Figure 3, item 40) to a serial port of the PC using the PCLINK cable (accessory item, see Figure 15) or use the USB socket of the control Panel (see Figure 3 item 26) and a USB cable (Type A-A) or the USB cable **USB5M** (508.032.037) (length 5 m.).
- To connect the control panel to PC remotely: install the FC500IP board, as described in the paragraph "Installing FC500IP board".

If the control panel is **not connected** to your PC, the warning "**Response from Panel Timed!**" will display. If the serial port for the local communication is invalid, the warning "**Cannot open serial port**" will be shown.

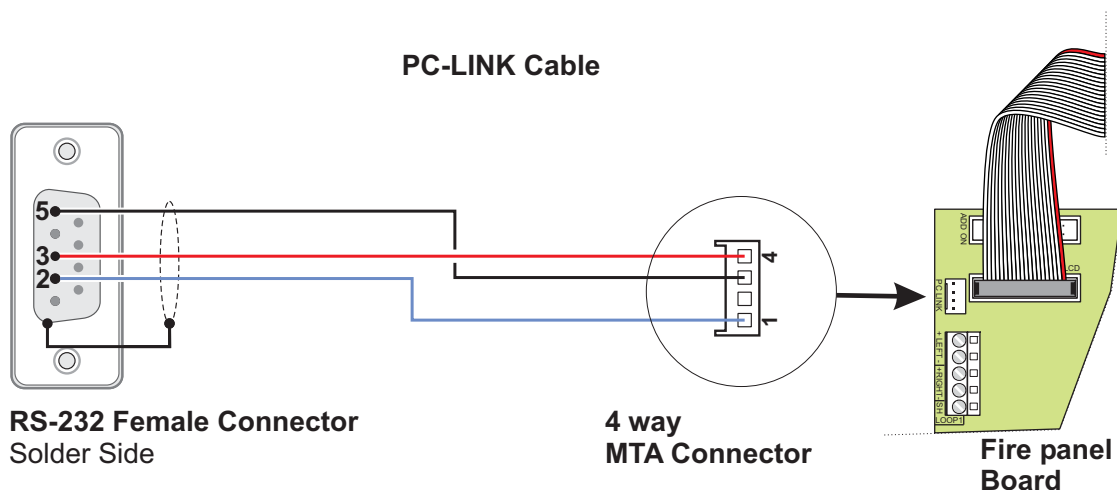







Figure 15 Schematic diagram of the PCLink cable.

Main window

From the FireClass Console main screen, select "**File**" and then "**New**", to display the window as shown in Figure 16 where you can select the Firmware Release of the Control Panel to program. Click on the green tick to accept the selection. The following sections describe the **File**, **Tools**, and **Help** menus.

■ Icons

-  Opens the window "Panel Details" (Figure 18) where you can check/insert various programming.
-  Check Panel details, enter the name and address of the Control Panel/ Customer.(Figure 18)
-  Download the programming (via serial link) to the connected control panel.
-  Upload the programming of the connected Control Panel.
-  Select the Loop for inserting devices.
-  Start operations in Real Time. This feature allows you to view the status of the FC501 control panel in real time on a computer using the FC500IP module connected to the network or using the serial port.

■ File menu

The menu **File: New, Open, Save, Save as, Close, Exit** will allow you to manage customer account data.

New creates a New installation and assigns the factory default values to all programming parameters.

Open retrieves a previously saved customer installation file. Locate the required installation file and double click it to open it.

 You can have more than one installation file open at the same time. Pay attention to the tabs on the left-hand side to ensure you are editing the correct file.

Save If the installation data is modified, click on "Save" to save the changes to the current installation.

Save as If you have created a new installation or want to save an existing installation under a new name then click on "Save as".

Close closes the current installation. You will be prompted to save any changes made.

Exit closes Fireclass Console. You will be prompted to save any changes made to the current installation.

Figure 16 From File menu and then "New".

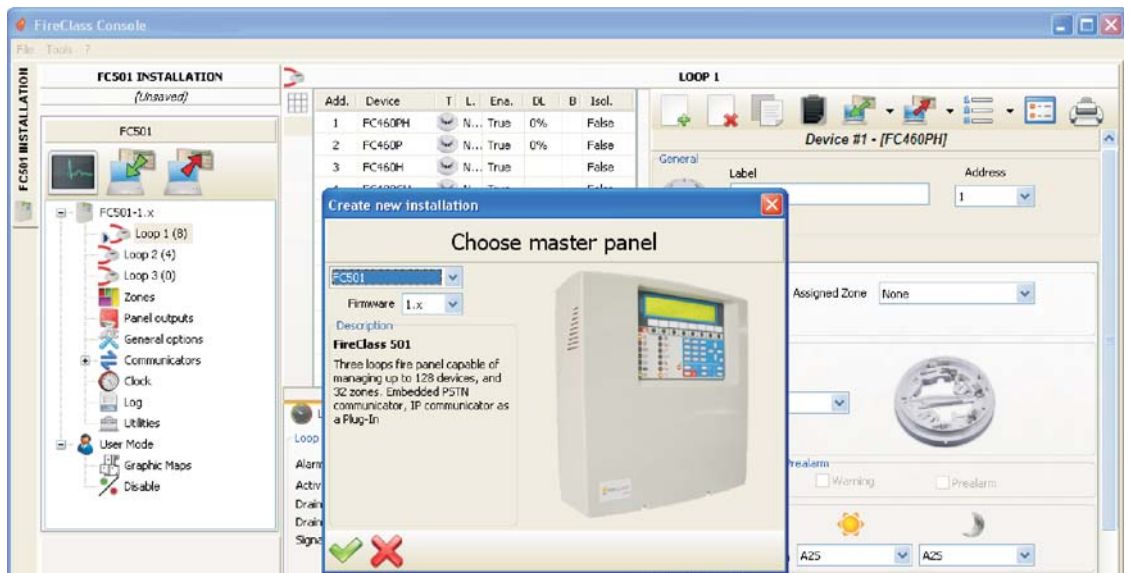

■ Tools menu

Language See paragraph "Select language" on page 32.

Skin To change the look of FireClass Console, click on **Tools** and then **"Skin"** that allows to choose the available looks from a list.

Advanced In this section you can set the Tooltip duration. Load the driver to use the USB. It is also possible to associate the files .FCI (files generated by the programming/management of the fire system) with FireClass console.

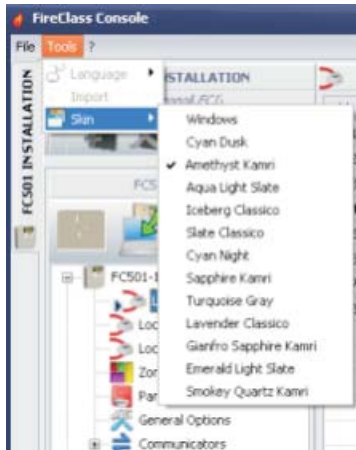



Figure 17 To modify the window look (skins).

■ Help Menu

Click on the **Help** option and a technical support file will open. This application allows you to learn about and use of FireClass Console.

Panel Details

Click on this icon  and the following menu tabs will be displayed (Figure 18):

- Panel
- Communication
- Panel Language
- Firmware Update
- Screen Saver
- Account.

■ Panel Details Menu

In this window, you can enter the name of the Panel/Customer.



-  Check the firmware version of MainBoard, Loop controller, User Interface, Repeater and FC500FMI module.
-  restores the Control Panel to the factory default.
-  opens the Installation Manual.

Figure 18 Control Panel Details window.

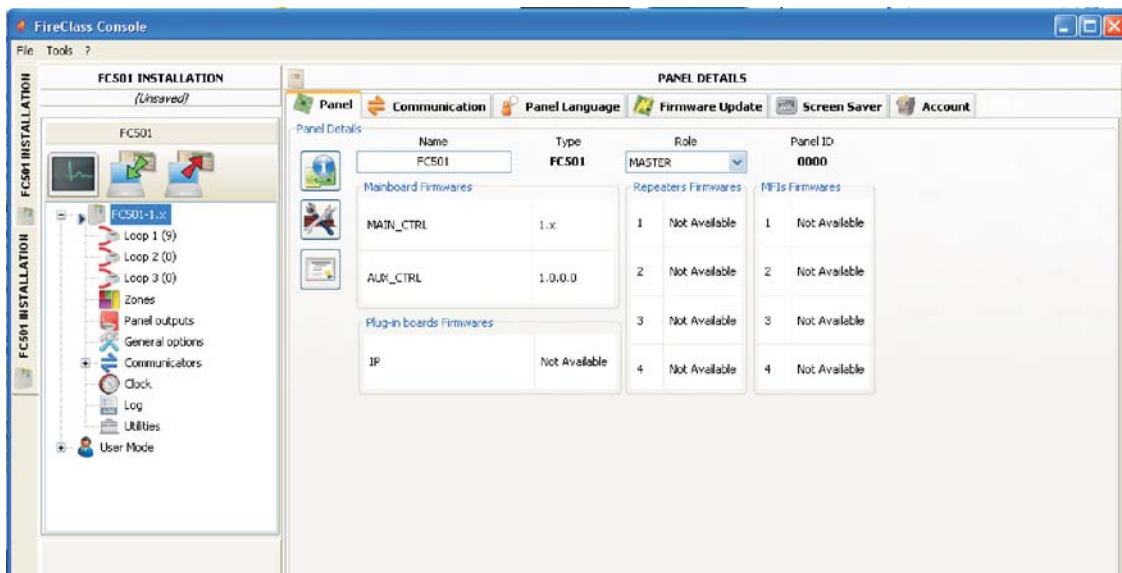
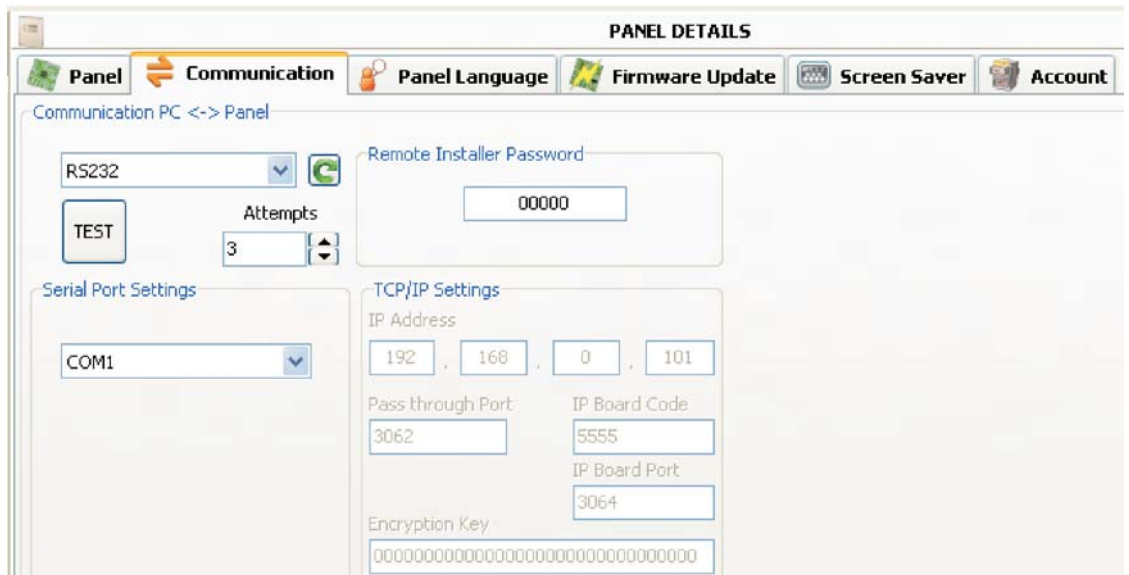



Figure 19 *Communication window.*



■ **Communication Menu** 

In the Communication menu, you can choose the connection mode between the Panel and the PC: TCP/IP, RS232 or USB.

Click on  to update the type of connection. Click on the **TEST** button to verify the functionality of the connection status. In the TCP/IP mode, it is necessary to enter the FC500IP parameters and the Installer password already in the system.

The IP Module screen is used to program the parameters corresponding to the IP Module as described below.

- **IP address** – Enter the IP address assigned to the IP Module you wish to program or, if DHCP (dynamic IP address) mode has been selected, contact the network administrator to request details of the IP address assigned to the IP Module. Alternatively, follow the procedure outlined in the “View IP address” paragraph to view the IP address on the control unit display.
- **Dynamic DNS Service** – Control and monitor the panel remotely using ethernet - a dynamic DNS service. Graphic maps can now be used without a static IP address assigned by an internet provider to the supervisor site. Add the necessary fields to the configuration software in the FireClass Console. This allows the user to connect to the control remotely using a fixed literal domain name (for example, mysupervisedsite.dns.org). The user can avail of this site instead of a numeric IP address.

The default setting is 192.168.0.101.

- **IP Module port** – Enter the details of the port assigned to the IP Module you wish to program (contact the network administrator).

The default setting is 3064.

- **IP Module code** – Enter the access code assigned to the IP Module you wish to program. The default setting is 5555.

Encryption key – Enter the encryption key assigned to the IP Module you wish to program. The default setting is 32 zeros.

■ **Language Menu** 

The Language menu allows you to change the system language (User Interface or Repeater) to any of the languages currently loaded using the following steps:





1. In the **Loaded Language** section, select **Change System Language** .
2. Select the language and the device (User Interface or Repeater).
3. Select  to override the language in the Control panel memory.
4. When the download of the new language is complete, the panel will start to use it and it will update any peripherals, if necessary.

Figure 20 *Firmware Update window.*

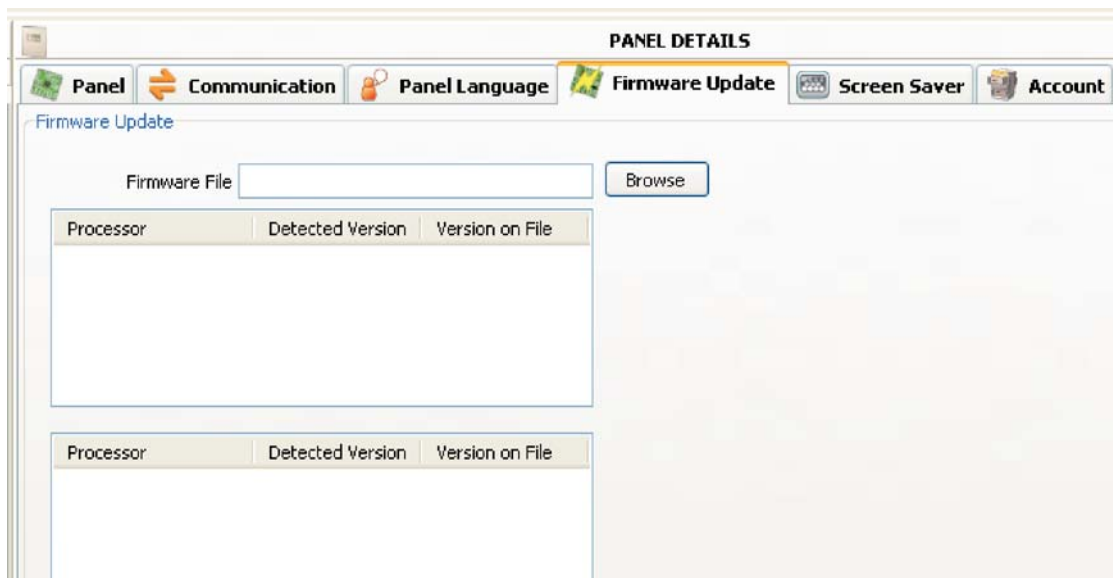

■ **Firmware Update menu** 

Click on “Firmware Update” (see figure 20). From a source file, a Firmware Update of all system interface including the Mainboard, User interface, Loop controller and Repeater can be carried out.

 *If the FC500REP repeater has a Firmware V3 or less, and the language is Italian while it is English on the Panel, the installer will have to realign the strings of languages after the firmware update, using the language change process (see **Program 8 Key-System**).*

■ **ScreenSaver menu** 

In the ScreenSaver menu it is possible to insert 4 lines of text (such as Installer address/telephone) which will be loaded on the display of the User Interface when the panel is in the stand-by status. The four rows can include: Steady, Scroll or Blink.

■ **Account Menu** 

In the Account menu enter the account data, and for better identification of the account, after entering the address (location) by clicking on the address field, the software will attempt to find the address using Google Maps (if an active internet connection is present).

Figure 21 *Account window.*

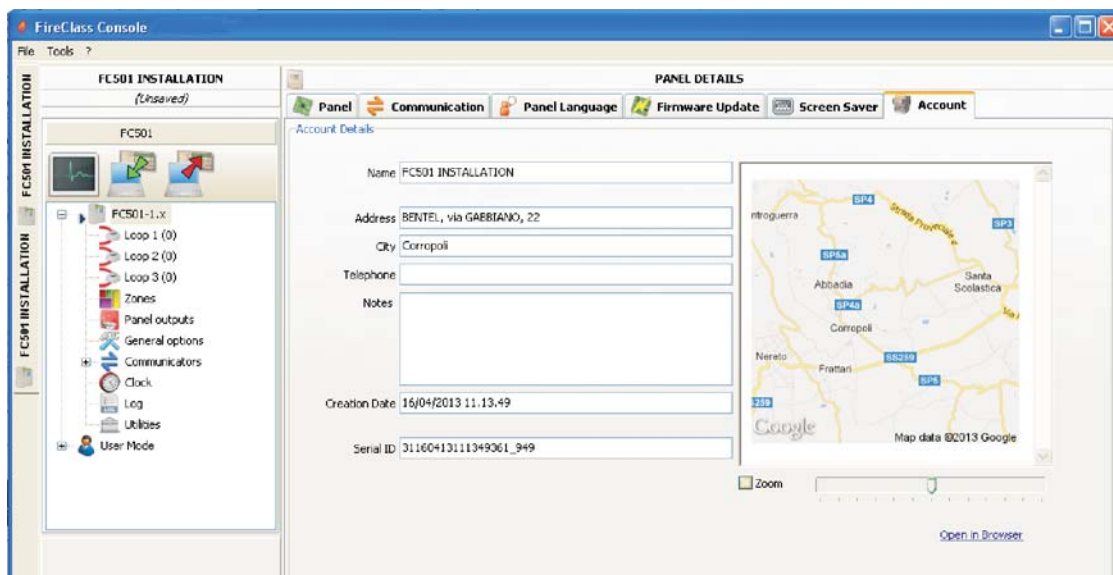

Programming Pages

The programming pages of the system are:

- Loop devices
- Zones
- Panel Outputs
- General Options
- Communicators
- Clock
- Log
- Utilities
- User mode

More details on these pages are provided in the following sections.

Loop Devices programming

In the window on the left, click on the panel name to expand the tree view. Then click on the required loop (1,2 or 3). The devices programming window will be displayed (Figure 22).

On the right of Loop1 or Loop 2 or Loop3, the current number of devices is shown in brackets ().

Description of the icons in the tool bar.











-  Add Device: select new devices.
-  Remove device: remove the installed devices.
-  Copy device on the clipboard: allows you to copy the device data to the clipboard for use in another account.
-  Paste clipboard content: allows you to add device data previously copied to the clipboard.
-  Read Loop: allows you to upload the current loop data from the panel (via the serial data link).
-  Send Element(s): allows you to download the current loop data to the panel (via the serial data link).
-  Device's details: this open a new window to allow you to see status of the device.
-  Selection: allows you to select all devices or invert the current selection.

Figure 22 Devices programming window

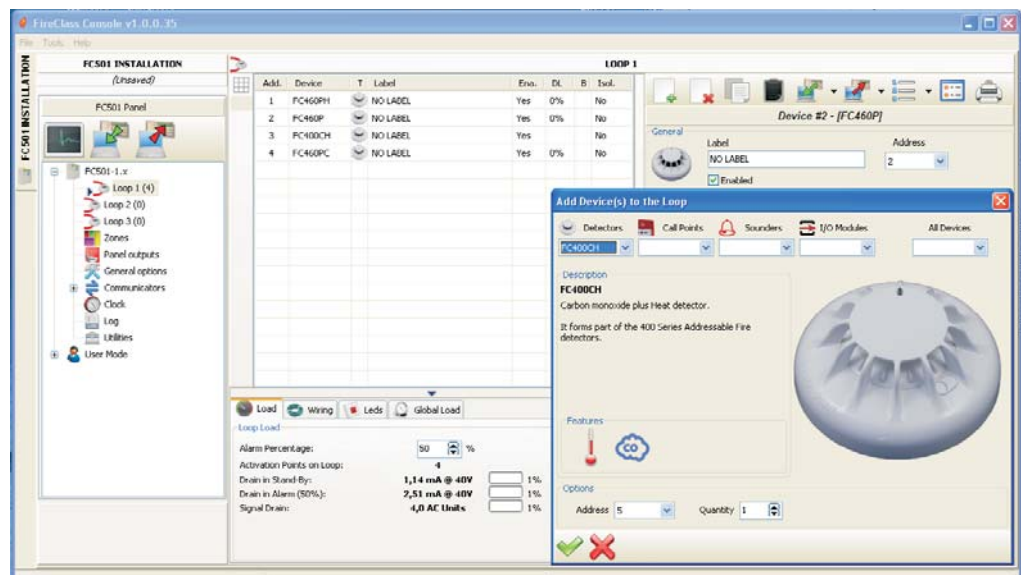

-  Print to file: the list of devices of the selected loop can be printed to a .csv file. The .csv file can be edited using Microsoft Excel.

If different devices have common programming parameters, you can use the multiple selection of the devices and assign the same parameters.

Select devices Click on **Panel 1**, select **Loop 1** or **Loop 2** or **Loop 3**, click on “new device” . The window in Figure 22 will display. Select the programming device, check the address, (autoaddressing) and click on the tick (Enable) to add the device to the loop. For others devices, repeat the same procedure. The detector type is shown by the icon in the Features field.

Remove devices Select the device in the list. Click on “Remove device” . Click YES to remove or NO to cancel (see Figure 22).

Loop Loading The **Loop Load section** is located at the bottom of the programmed devices list (Figure 23). In this section the number of Activation points on the loop, the Drain in stand-By, the Drain in Alarm and the Signal Drain are displayed. The Alarm percentage can be adjusted.

The remote LEDs may be entered in the calculation.

The percentage shown in the “Loop drain in alarm (50%)” is the programmed value in “Battery calculation” an option of **Utilities page** (see dedicated paragraph), for the battery calculation after the cable length is entered. It is possible to choose the type of cable if you have a database.

■ Loop wiring Calculation

The Loop Wiring is located beside the Loop Load tab. This gives you the maximum permitted resistance of the loop based on the cable length and the Alarm Percentage. If cable data is available from the Utilities section then suitable cable may also be shown.

■ Detectors parameters programming

Click on a device in the Device list. The relevant device programming window will be shown on the right (every device has the dedicated programming window).

For the detectors (see figure 22);

in the **First section (GENERAL)**:

- **Enabled:** a tick [✓] indicates that the detector is enabled.
- **Label:** this is for the editable device-label. The system will use the label as the device **identifier**.
- **Address:** in this field you can modify the address of the detector.

OPTIONS section:

LED Blinking: a tick [✓] indicates that the LED detector will flash.

- **Assigned Zones:** each fire detector, Input module and Manual call Point can be associated with 1 of the available software zones (32 for FC501 control panel). If a device goes into ALARM status, the zones it is assigned will also go into ALARM status.

Base: In this section it is possible to select the base for the detector by clicking on the available bases. When the sounder base type has been selected, a new programming tab Base is made available which opens the sounder base programming page. On this page the trigger zones, the trigger points and the trigger event conditions can be selected and the following parameters can be configured:

Parameter	Result
Enabled	When selected, the base is enabled. Otherwise the base is disabled
Label	20 characters base label
Silenceable	Sounds until SLIENCE/RESOUND SOUNDERS button is selected. Otherwise sounds until RESET button is selected
Set As SC1	When selected, the base will behave as the Sounder Circuit 1 SC1
Monostable	When selected, the base sounds until the MONSTABLE OUTPUTS TIME elapses

- **Remote LED** In this section it is possible to activate the programmable **Remote LED** of the detectors. The detectors have an output used to drive the remote LED. This output is only activated for detector alarm to which it belong. Now, it will be possible to program it to activate for other events, exactly as it happens for the other panel outputs, as well as for the detector alarm which it belongs.

☞ This option (Remote LED) will be possible to program also on control panel User interface, in the programming page of the detectors.

PROCESSING for WARNING/Delay to Alarm section:

this determines the actions the control panel will perform when the device threshold is exceeded.

- **Use zone settings:** the detector uses the parameters of the assigned zone; if this option is disabled, the Warning and/or Delay to Alarm time can be manually selected.
- **Delay to Alarm:** the control panel will activate the ALARM delay.
- **Warning:** the control panel will activate a WARNING signal.

Depending on the type of detector: Smoke, Heat, Smoke and Heat, Heat and Carbon Monoxide (CO), Smoke Heat

Figure 23 Detectors parameters programming Window

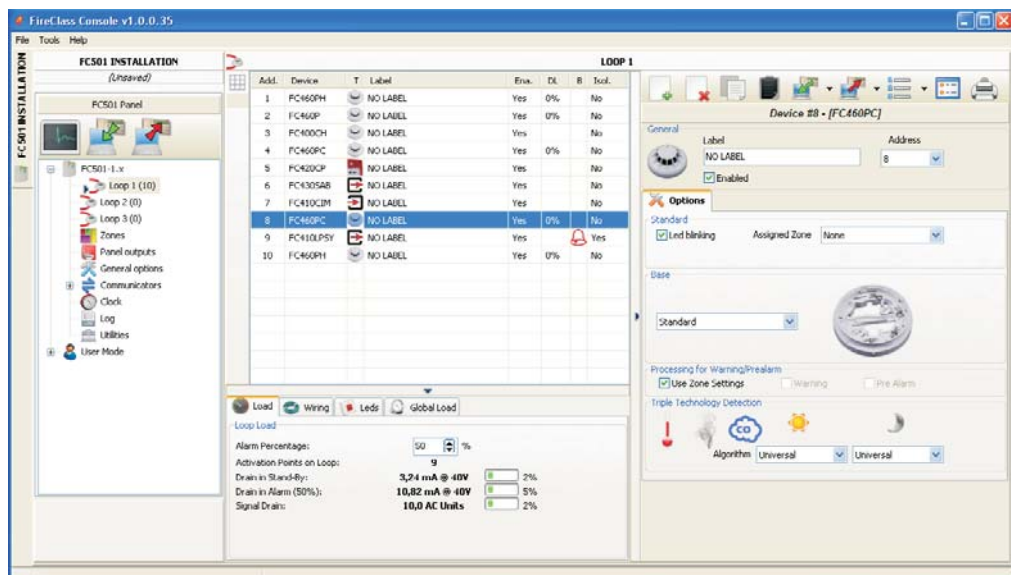

Detector Class	Typical application Temperature °C	Max. Application Temperature °C	Min.Static Response Temperature °C	Max.Static Response Temperature °C
A1	25	50	54	65
A2	25	50	54	70
B	40	65	69	85
C	55	80	84	100
D	70	95	99	115
E	85	110	114	130
F	100	125	129	145
G	115	140	144	160

Table 8 Detector classification Temperature - Detectors will conform to one or more of the following classes: A1, A2, B, C, D, E, F or G . Manufacturers may optionally give additional information concerning the type of response exhibited by the detector, by adding the suffix S or R to the above classes. Detectors, with a suffix **S** to their class, do not respond below the minimum static response temperature, even at high rates of rise of air temperature. Detectors, with a suffix **R** to their class, incorporate a rate of rise characteristic, which meets the response time requirements for high rates of rise of air temperature even when the air temperature starts substantially below the typical application temperature (EN54-5:2000).

and Carbon Monoxide (Co), will have three sections:

OPERATING MODE HEAT DETECTOR SECTION:

☀ Day mode- 🌙 Night mode for Temperature detector (see table 8), choose the Class of the selected detector.

OPERATING MODE SMOKE DETECTOR SECTION:

☀ Day mode- 🌙 Night mode for Smoke and Heat detectors:

- **Drift Compensation:** Drift compensation effects optical smoke sensors only. It will supply a precise analysis about dust accumulation, and therefore, the alarm threshold will be modified accordingly (false alarms).
- **Default:** for smoke detectors only and for Smoke and Heat detectors only;
- **Enhanced:** for Smoke and Heat detectors only;
- **Sensitivity:** Sensitivity can be set: **Low**, **Medium** and **High**.

OPERATING MODE CARBON MONOXIDE SECTION:

☀ Day mode- 🌙 Night mode for Co and Heat detectors:

- **Default**
- **Enhanced**
- **Disabled**
- **Sensitivity**, this can be set to: **Low**, **Normal** or **High**.

For the FC460PC detector (Smoke, Heat and Co) can be set to: HIGH IMMUNITY or UNIVERSAL, in the **TRIPLE TECHNOLOGY DETECTION**.

☞ Click on  to open or close the relative section of parameters programming

☞ If a detector linked to an Output or Input-Output Module, is disabled (remove a tick [✓] in the proper section), a window will show to ask confirmation. Click on Detail to see further data.

☞ For the sirens of the FC410LPA/S series and the base FC430LPA/S, in the "Sounder Options" section you can set the tone, volume and frequency of flash of the beacon.

☞ For the sirens of the FC410LPSY/AV series you must also choose the Subtype.

Input module parameters programming

Click on an entered Input Module, the relevant programming window will be shown as per the following description.

- First section:** as per the Detectors section;
Assigned zone: as per the Detectors section;
Second section: select the operating mode style: B, C. There are 2 operating mode style: B, C;
- **B style:** two wire connection mode: the short-circuit condition as an Alarm condition.
 - **C style:** two wire connection mode: the short-circuit condition as a Fault condition.

☞ As different styles are selected, the electrical operating diagram changes

PROCESSING for WARNING/ Delay to Alarm section: see the same section in the **Detectors parameters programming**.

☞ For every digital input of loop devices, the **Restorable warning** parameter (when **Warning** option is selected for the input) can be programmed. This can also apply to the Multiple Input-Output modules but not for the detectors. When this option is programmed for a certain input, the control panel will enter the **Warning status** when the appropriate conditions are detected by the input, and will exit this status when the loop device goes back to standby status.

☞ When the loop device is activated and the **Warning** event is generated, the LED of the device will be switched ON. When the event is **restored**, the LED will be switched OFF.

For the **FC410DDM** module only, it is possible to set the thresholds of gas detection by selecting **Conventional** (for conventional detectors), **Gas Source** or **Gas Sink** (for signalling detectors). In addition:

- **LED blinking:** click on to enable/disable signaling LED module.

- **External Power:** click on to enable/disable an external 24Vdc PSU.

For the **MIM module**, you can enable Fast mode in Style B or Style C/NO connection. When Fast Mode is enabled, the activation of the module will be detected by the control panel within 2 seconds.

 *A short circuit fault will be detected quickly while its restoration will be slow as with the other faults. Default: disabled.*

■ Output module parameters programming

Click on an entered **Output Module**, the relevant programming window will be shown as per the following description.

FIRST section: as per the Detectors section.

SECOND section: Trigger zones; each Output module can be triggered by up to 4 of the 32 available software zones for FC501 panel. An Output module will be activated when any of the selected zones are triggered, reach the status condition configured in the Fourth section (Zone row).

Base: in this section, the base for the Output module can be selected; click-on available bases (for FC430SAM and FC430SAB only). Once the "sounder" base is selected, a new programming tab labelled "base" allowing access to the sounder base programming page, where the trigger zones, the trigger points, the trigger conditions can be selected and the following parameters can be configured:

Parameter	Result
Enabled	<i>When selected, the base is enabled. Otherwise the base is disabled</i>
Label	<i>20 characters base label</i>
Silenceable	<i>Sounds until "SILENCE/RESOUND SOUNDERS" button is pressed when selected. Otherwise sounds until "RESET" button is pressed.</i>
Set As SC1	<i>When selected, the base behaves as the Sounder Circuit 1 SC1</i>
Monostable	<i>When selected, the base sounds until the monostable outputs time elapses</i>

Beacon: Activate the blinking or glowing (ON).

THIRD section: Trigger points. each output module can be assigned to 3 Activation points : in this case the Output Module is activated when at least one of the Input points to which it belongs is in a alarm status, indicate:

- the loop which the device is connected to;
- the device address.

FOURTH section: Options, these options will allow you to select the conditions that will activate the output module:

- Zone warning, Zone fault, Zone Delay to Alarm, Zone Alarm, Zone Double Knock, Zone Test;
- Point warning, Point fault, Point Delay to Alarm, Point Alarm;

- Panel warning, Panel fault, Panel delay to alarm, Panel alarm,
- Network fault.

It is also possible to program the Output Module as: **Silenceable, Set as SC1, ACTIVE ON DISABLEMENT, MONOSTABLE, TIMED WARNING** (see Outputs programming).

- **Linked Delay:** see the same option in the paragraph "Panel Output Programming".

For the following types of devices:

FC410LPAV (all versions)

FC430LPASB

FC430SAB (with **FC430SB**),

In addition to those certified to EN54-23:

FC410LPS-R/W

FC410LPBS

FC430LPBSB,

It is possible to separate the programming of the Sounder and Beacon, in two different programming tabs. The two tabs, for Sounder and Beacon, have the same programming options, except for "**Set As SC1**", which will be present only for the Sounder output.

 *It is not possible to separately enable/disable the two output channels.*

 *The separate programming of the Sounder and Beacon of the devices (named previously), it will be possible also by Control Panel User Interface in the Devices programming pages.*

Pulse On: If the **Pulse On** option is disabled, the sounder sounds steady. If not, the sounder sounds a pulse (2 seconds on, 2 seconds off) as indicated by the following options. In all cases, the tone of the sounder is based on the selection in the **Options** page.

 *The sounder sounds continuously for the **Fault, Double Knock and Test** events*

 *Disable **As General Options** to make the **Pulse On** options of the selected sounder different to the settings in the **General option > General Outputs Settings** page*

Detector Alarm: If enabled, the sounder will pulse when the programmed **Alarm** event is triggered by a detector. Default: disabled.

 *The sounder will sound continuously when the programmed **Alarm** event is triggered by a call point or by the **EVAC** button, independently by the **Detector Alarm** option set.*

Delay to Alarm: If enabled, the sounder will pulse when the programmed **Delay to Alarm** event occurs. Default: disabled.

Warning: If enabled, the sounder will pulse when the programmed Warning event occurs. Default: enabled.

Sounder Options: In the programming page of the loop sounders there are 3 controls to set the **Tone, Volume,** and the **Beacon** frequency for **Alarm, Delay to Alarm** and **Warning** event types so that each type of event causes a different sound or LED blinking. If different types of trigger events are active at the same time for a sounder, this sounds with the highest priority tone.

 *Disable As General Options to make the **Sounder options** of the selected sounder different to the settings in the **General option > General Outputs Settings** page*

Default Volumes: maximum for Alarm and Delay to Alarm, minimum for Warning.

Default Beacon Frequencies: 0.5Hz.

■ Multiple Input-Output Module - Parameters Programming (FC410MIO/FC410QIO)

Click on an entered **Multiple Input/Output Module** FC410MIO (3 Inputs and 4 Outputs Module) or FC410QIO (4 Inputs and 4 Outputs Module), see the customized Manuals, the relevant programming window will be shown.

The options descriptions are as per the Input and Output Modules paragraphs. In the field "Label" a description of Input/Output Module will be inserted.

For Trigger Points see same section on "Output module parameters programming".

OPTIONS section:

➤ **Oppo interface: ActUnit/KeySafe,** allows you to manage the procedure for the automatic opening of the doors of the factory / Office / Shop, Warehouse, in case of fire. This avoids the breakage of these structures. The outputs of this module can control these actions.

➤ **LED blinking:** click on to enable/disable signaling LE. The **FC410TSM** Door Control Module (one Input/one output) designed to close a fire door in case of alarm or fault. The FC410TSM monitors:

- the external Power supply;
- Loop voltage Test, if the relevant option are enabled.

 *In an eventual connection on the right side (2 wires connection), the module enables the yellow (isolator) LED blinking (Not correct installation)*

■ Manual Call Point parameters programming

Click on a **Manual Call Point** (FC420CP, FC421CP) the relevant programming will be shown as per the following description. GENERAL section: as for the detectors;

OPTIONS section:

➤ **assigned zones:** each Manual Call Point can be associated with 1 of the available software zones (32 for FC501).

➤ **Led blinking:** if this option is enabled, the Manual Call Point LED will blink every Loop scanning.

Zones programming

The **Zones** option from the panel tree menu will allow you to access the software-zone parameters (see Figure 24). The software zones parameters will be applied automatically to all the devices associated with the zone concerned.

GENERAL section (FIRST section)

- **Enabled:** a tick indicates that the zone is enabled.
- **Label:** this is for the editable device-label (up to 20 characters). The system will use the label as the zone **identifier**.

OPTIONS section: a number of parameters can be programmed in this section.

Walk test:

- **Active:** if enabled, the zones in alarm status will activate the programmed Outputs with Walk test event, while the control panel will not generate an alarm. Select if the event is fired by:
 - Any device means Modules + CP + Detectors
 - CallPoints means CPs only
 - Detectors means Modules + Detectors (No CPs)

Delay to Alarm:

- **Delay to Alarm:** if this option is enabled, the control panel will activate the ALARM delay.
- **Double Knock:** if this option is enabled and the zone is in the Delay to Alarm status, when any other devices (other address) associated to this zone are activated, the zone will immediately generate an Alarm status.

☞ If the "Use zone settings" option is not checked for a device, it means that you can individually decide, for that device, if it has to process Warning and/or Delay to Alarm. Once you have decided that the device processes delay to alarm, its activation will cause the delay to alarm of the panel (with panel delay to alarm time) and, because it belongs to a zone, that zone will go into the delay to alarm status. If another point belonging to the zone goes into Delay to Alarm, the Double Knock option becomes active if enabled in Zone programming page.

- **Delay to Alarm Duration:** an input device programmed with Delay to Alarm time will generate ALARM status when the delay to alarm time elapses. (see parameters programming detector). Select the Delay to Alarm time. The delay to alarm time can be set from 0 seconds to 300 seconds in 1-second steps. **Other:**
- **Drift Compensation:** see the same option in "Parameters detectors Programming".
- **Detector Warning:** if this option is enabled, the control panel will activate a WARNING signal. N.B. To activate the Warning option for a Module, tick the corresponding box on the Module programming screen.
- **Smoke delay:** for each zone, you can program the delayed activation of the smoke detectors. The SMOKE DELAY (60 seconds/30 minutes) parameter, when set, applies to all smoke detectors assigned to the selected zone the alarm verification algorithm as described in the EN54-2.

☞ Under the list of Zones (Zone Programming page, see figure 24) two windows are displayed which devices and what outputs are enabled on it. If you click the right mouse button on a Device in the list, a new menu will be displayed. Selecting Device Details will open a new window, where it is possible to see what points and what output is assigned to the device.

COMMUNICATORS section:

PSTN: each zone can be associated with one or more voice messages linked to an Alarm, Delay to Alarm, Start-up, Breakdown or Walk Test event. These may be sent to a maximum of 32 telephone numbers.

IP: see PSTN above.

☞ The Communicators section will be activated after that the PSTN and/or IP communicator are enabled (double clicks) in the General Options page.

Figure 24 Zones Programming window.

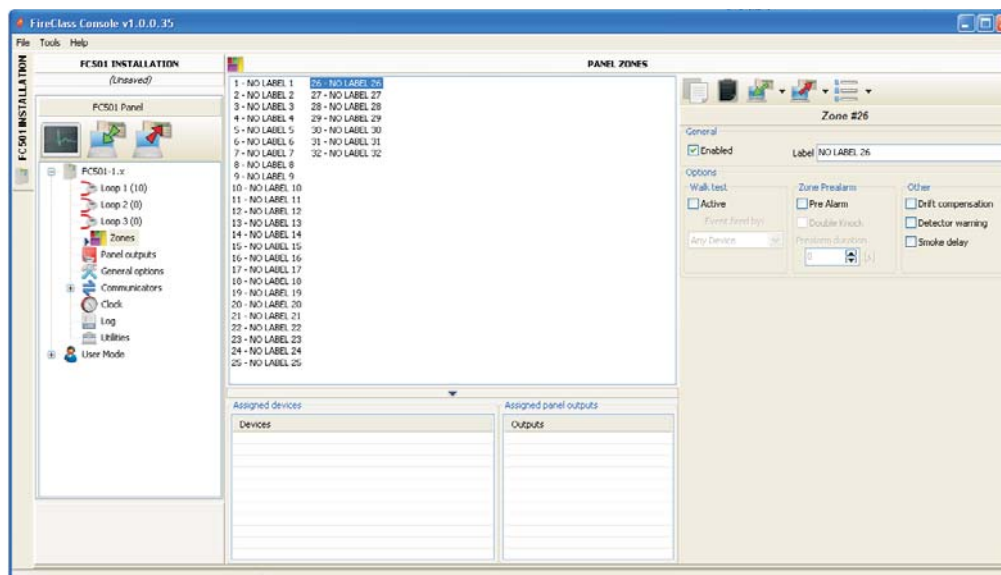

Outputs Programming

The **Panel Outputs** option will allow you to access the outputs parameters. The relevant programming will be shown as per the following description (see Figure 25).

■ SC1, SC2 Outputs

Supervised/Silenceable/Bypassable (Disabled) Alarm Outputs.

Output ACTIVE: positive pull-up to 27.6 V on the [+] terminal; negative pull-down to 0 V on the [-] terminal.

Click on an Output, the relevant programming window will be shown:

In the **GENERAL** section:

- **Enabled:** a tick [✓] indicates that the Output is enabled.
- **Label:** this is for the editable Output-label. The system will use the label as the Output **identifier**.

In the **ZONES** section, each Output can be triggered by up to 4 of the available software zones (32 for FC501 fire panel).

In the **TRIGGER POINTS** section, each Output can be triggered by 3 Input Points. For each Point it is necessary to indicate the address.

In the **OPTIONS** Section you can select the conditions that will activate the **outputs**. For example: if the "Zone warning" option is enabled, the control panel will activate the output when one of its associated points goes into Warning status.

- Warning Zone, Fault Zone, Delay to Alarm Zone, Alarm Zone, Double knock (see Zones programming), Walk Test Zone;
- Point Warning, Point Fault, Point Delay to Alarm, Point Alarm,
- Panel Warning, Panel Fault, Panel Delay to Alarm, Panel Alarm, Network (RS485) fault
- **Set as SC1**

If this option is enabled, the output behaves as the Sounder Circuit 1 (SC1).

☞ *When **Set as SC1** has been enabled, the **SOUNDERS FAULT/DIS LED blinks** if any output "set as SC1" fails. It remains **Glowing** if any output "set as SC1" is disabled.*

- **Silenceable** The output, if activated, can be Silenceable by checking this option. In the case of output silenceable, once silenced, it will be automatically reactivated in the case of a new fire event.
- **Active on Disablement** Click on this option to activate the programmable SC outputs when any part of the system is disabled.

☞ *This feature will be available for all programmable control panel outputs and for loop modules which provide dry contacts. This is the list of the devices affected by the modification: programmable control panel outputs: OC1, OC2 and FIRE. Loop modules: FC410RIM, FC410SIO, FC410MIO, FC410QMO, FC410QRM, FC410QIO*

- **MONOSTABLE:** Allows the relevant output to automatically deactivate when the "MONOST.OUTPUT TIME" elapses.
- **As General Options:** override the **Pulse On** local selection forcing the selection of the **Pulse On** in General Options settings.
- **Timed Warning:** becomes available if a warning trigger event is selected for the output. If enabled, the sounder will activate when the programmed warning trigger events happen, for the time specified by the **Timed Warning duration** option, the sounder will activate. Default: disabled.
- **Linked Delay:** one of the 5 available timers (set using the General Options page on **Delays Thresholds**) can be associated with an output activated by a zone, point or control panel alarm. The output will be activated by the programmed event, after the delay indicated by the Timer.

■ OC1, OC2 Outputs

These are programmed, NON-SUPERVISED, non-silenceable, bypassable (Disabled) outputs.

These are normally-open terminals (open-collector) which close to ground when the corresponding zones go into alarm status. These terminals will remain closed to ground even after the generating event has ended.

Figure 25 Outputs programming window.

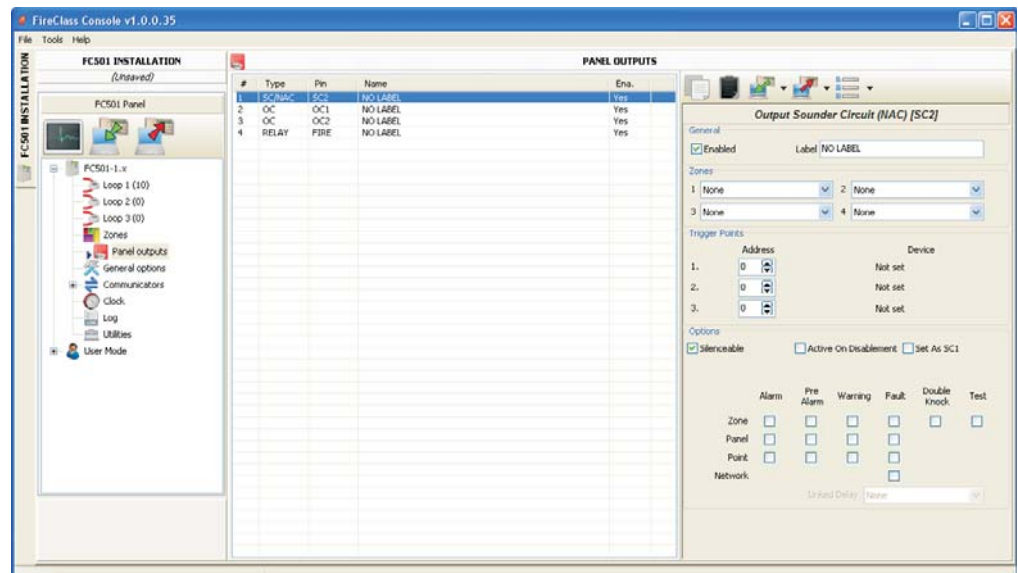

See the descriptions of the common parameters as per SC1, SC2 Outputs.

- **Backup PSTN line** For the output OC1 ONLY, use to drive an external relay to switch on the secondary telephone line, if any, in the case of a failure with the primary telephone line.

The **Options** section contains parameters for setting the conditions to activate the outputs (see same section in the SC Outputs paragraph).

■ Relay Outputs

- **Relay FIRE** Non-supervised **Fire** output. Dry contact relay for non-supervised devices.
- **Relay FAULT** Non-supervised **Fault** output. Dry contact relay for non-supervised devices.

👉 *EN54-2 certification applies ONLY when FAULT output is not J (EN 54-1) type, therefore this output MUST NOT BE UTILIZED to manage Fault transmission devices.*

The **Options** section contains parameters for setting the conditions to activate these outputs (see same section in the SC Outputs paragraph).

General Options programming

The Panel parameters can be programmed through the **General Options** page (see Figure 26).

In the **General** section  :

- **Loop Wiring:** select a **2 wire** connection or a **4 wire** connection for the Panel Loop configuration.

When the "2 wires" option is selected, it is possible to connect devices on both left and right sides of the loops (two spurs). This provides the capability to connect up to 6 spurs to the panel, mimicking a 6 zone conventional panel.

Notes

1. In the description of events, the devices are indicated as belonging to a loop. In the case of open loops, it is not possible to distinguish between the left and right side. The loop concept, however, will not be meaningful by definition, and localization will be performed via zones, as for conventional panels.
2. If devices are addressed by the Service Tool, there are two options to set them in 6 zones which correspond to the 6 spurs:
 - a) Connect addresses from 1 to 16 to the left side of loop1, from 17-32 to the right side of the loop and so on. Perform the enroll procedure and choose the "By address" option for zone assignment (devices on the left side of loop 1 will be assigned to zone 1, those on the right side of loop 1 to zone 2 and so on.
 - b) Assign the correct zone to each device via the PC Console or the control panel LCD.
3. If the devices are not addressed, the mapping procedure will be performed to locate each device and assign the proper zone to it.

Figure 26 General Options window

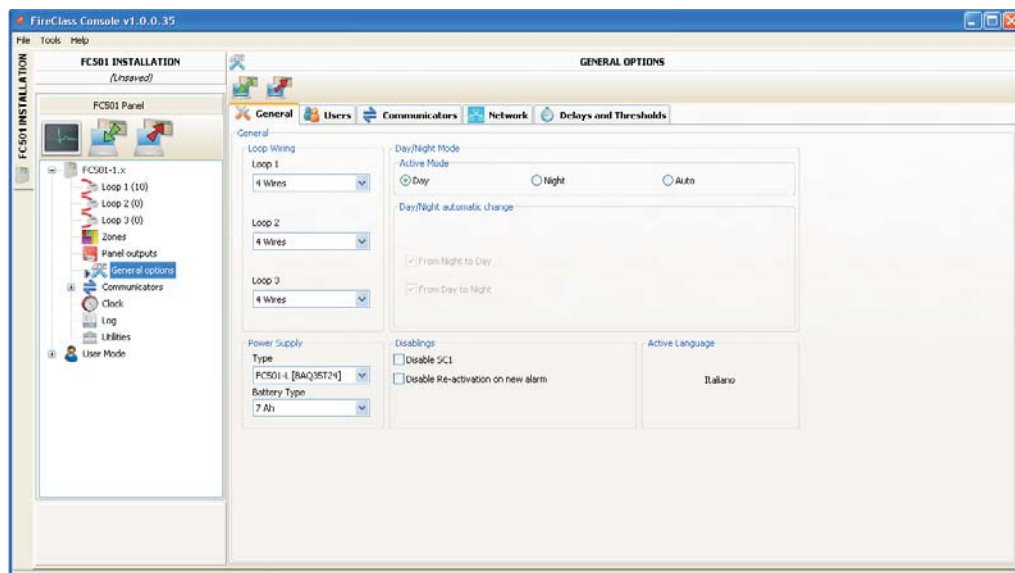

- **Day/night Mode:** select the operation mode: **Day Mode** ☀️, or **Night Mode** 🌙: or select **Automatic** to set the time (hour and minutes) of transition from one mode to another.
- **Disable screen saver:** allows the user to enable or disable the screen saver on the main page of the control panel LCD. The user can program the screen saver from the control panel User Interface or the FireClass Console. If the screen saver is enabled, it is displayed on the LCD. If it is disabled, it does not appear. This feature is not available for repeaters.
- **Power Supply:** select the Power Supply of the system: BAW50T24 or BAW75T24.
- **Disabling: Disable SC1.**
 - Allows disabling of the SC1 output (enabled by default). This Output is programmable. It is activated every time the control panel goes into ALARM status.
- **Re-activation of new alarm.** The following options can be selected:
 - "No Reactivation" where outputs are not reactivated once silenced.
 - "Alarm on other zone" where the outputs will be reactivated when a new zone goes into Alarm.

In the **USERS section** 🗑️, it is possible to change the installer code and user code. Each code must be 5 digits and can include digits 0-9.

- The Installer code allows you to manage the 3 access Levels of control panel: L1(View), L2 (User), L3 (Installer).
The **default installer code** is **00000**:
one click only - the password is present.
a second click - the installer password is enabled.
- The User code allows you to manage 2 access Levels of control panel: L1(View) and L2 (User).
The **default User code** is **11111**:
one click only - the password is present.
a second click - the user password is enabled.
- **Lock Installers Password:** if you select this option, it is not possible to perform the procedure to change the password Installer from the panel User Interface: Program Menu, 0=L3 PWD Key.

In the **COMMUNICATORS section** 📡 it is possible to enable the PSTN functionality and the FC500IP module. In the **PSTN section**:

- one click only - the PSTN is present, but not enabled.
- a double click - the PSTN is enabled.

When PSTN is enabled you can also select whether to enable both events, alarm and fault or one of two.

IP section:

- one click only - the FC500IP is present, but not enabled.
- a double click - the FC500IP is enabled.

When IP is enabled you can also select whether to enable both events, alarm and fault or one of two.

In the **NETWORK** 🌐 **section:** a tick [✓] performs the following actions:

- **Enable Network.**
- **Allow buzzer silence** which silences a device that is activated in every part of the network.
- Enable Repeaters and FC500 MFI modules in the **Network Repeaters section** and **Network MFI section.**

- One click only the Repeater and FC500MFI are present, but not enabled.
 - A double click the Repeater and FC500MFI are enabled.
- For the FC500MFI module, see the Programming from the panel section.

👉 *The Repeater address can be inserted from the panel (see **Programming from the panel section**).*

DELAYS and THRESHOLDS section ⚙️ In this section, it is possible to program:

- The **ALARM DELAYS:** you can select 5 timers. When selecting the output in the Panel Outputs page, the timer will be set in the Linked Delay option.
- The **PANEL DELAYS**
- **Investigation Time:** a **Delay** will be added automatically to the Delay to Alarm remaining delay, when the **Investigate Key** will be pressed.

👉 *The sum of **Investigation Time** and **Delay to Alarm Time** must not exceed 10 minutes*

Fault delay: this field controls how long it takes for the panel to signal a Mains failure.

The Amber signalling LED (Power Supply Fault) will be ON and the relevant event will be shown on the display.

Delay to alarm duration: an input device programmed with Delay to alarm time will generate ALARM status when the delay to alarm time elapses.

Delay to Alarm status is signalled by:

- an audible signal emitted by the control panel.
- blinking on the DELAY TO ALARM LED (this LED is on the Repeater FC500REP only).
- the message on the display.
- activation of outputs with programmed delay to alarms.

Silence duration: when the control panel is in **Night Mode**, the Silence delay is the maximum silence time of the Outputs. To disable the Silence duration time, tick the checkbox "Disabled" located to the right of the time value entry.

Reset: program the Reset time (min time: 2 seconds; max time: 15 seconds.).

Monostable outputs time: When the "monostable" option is set for the outputs, the **monostable outputs time** defines, for the entire system, the period of time for which the outputs remain active once triggered. Values range from 1 minute to 30 minutes (The default value is 3 minutes)

Warning Sound Duration: This is the numeric value defining the time of activation of outputs which have the "Timed Warning" option set.

The value is valid for the entire system (every new trigger event of the programmed outputs will restart it).

Range: from 3 to 60 seconds.

Default value: 5 seconds.

Resolution: 1 second

The THRESHOLDS section is reserved for the DDM Gas Detector;

- **SET:** allows you to choose between 4 levels of threshold.

General Output Settings

In this section, the behaviour of the Sounder Circuit 2 (SC2) and loop sounders can be configured at a system level.

These configurations will be applied to the SC2 loop sounders when **As General Options** is enabled.

Pulse On: If the **Pulse On** option are disabled, the sounder sounds steady. If not, the sounder pulses (2 seconds on, 2 seconds off) as indicated by the following options. In all cases, the tone of the sounder is based on the selection in the **Panel Settings for Symphony Sounders** and **Panel Settings for AV Base Sounders** sections.

 *The sounder always sounds continuously for the **Fault, Double Knock and Test** events.*

Detector Alarm: If enabled, the sounder will pulse when the programmed Alarm event is triggered by a detector. Default: disabled

 *The sounder will sound continuously when the programmed **Alarm** event is triggered by a call point or by the **EVAC** button, independent of the **Detector Alarm** option set.*

Delay to Alarm: If enabled, the sounder will pulse when the programmed Delay to Alarm event occurs. Default: disabled.

Warning: If enabled, the sounder will pulse when the programmed Warning event occurs. Default: enabled.

■ Panel Setting for Symphony Sounders and Panel setting for AV Base Sounder

For each of the trigger events, **Alarm**, **Delay to Alarm** and **Warning**, it will be possible to select: the sounder **Tone**, the sounder **Volume**, the **Beacon** flash rate. Default Tones: *7Hz Fast Sweep* (Dutch Slow Whoop when the Dutch language is selected) for Alarm and Delay to Alarm, *2 Tone* for Warning. Default Volumes: maximum for Alarm and Delay to Alarm, minimum for Warning. Default Beacon Frequencies: 0.5Hz

Communicators Programming

The Communicators page is for programming the parameters of the PSTN interface, of the FC500IP module and of Panel events, as described below.

PSTN interface The PSTN interface section is activated, after the PSTN Telecom interface has been enabled on the **General Options** page (Figure 26).

In the OPTIONS section:

- **Call attempts** – Set the maximum number of attempts that the PSTN interface makes for each Telephone Number: set from 1 to 9, the default setting is 3 attempts.
- **Iterations** – Set the number of times the PSTN interface repeats the Voice Message: set from 1 to 9, the default setting is 3;
- **Tone Check** – If enabled, the PSTN interface controls whether it can obtain a **Dialling Tone** and if it can obtain it move to the next step. If not, it will consider the phone call failed and the hang up and try again.
- **Call All Telemonitoring** – If the **Call all Telemonitoring** numbers option is enabled, the PSTN Interface calls all the numbers which have been programmed for the event which has occurred, up to the time when all telephone calls succeed or, at the most, for the number of Call Attempts which has been programmed. If the **Call All Telemonitoring** numbers option is disabled, the PSTN Interface will interrupt the call as soon as it succeeds.
- If the **Call All Voice Messages** numbers option is enabled (default setting), the PSTN Interface will call all programmed numbers for the event which has occurred, until all phone calls fully succeed according to the number of Call Attempts which have been programmed. If the **Call All Voice Messages** numbers option is disabled, the PSTN Interface will interrupt the calls as soon as one is successful.

The section **PLAY MESSAGE AFTER** sets the condition for the playing back of the Voice Message.

- **Dialing** - the Message is played back as soon as the Telephone number is dialled.
- **Voice** - the message is played back when the PSTN Interface detects a voice answer.
- **Delay** - the Message is played back when the programmed Delay elapses after the Telephone number has been dialled. The Delay can be set from 0 to 99 seconds, with 1 second steps. The default setting is 0 seconds.

The section **PERIODIC REPORT** sets the parameters corresponding to the **Period Test**, as described below:

- **Date and Time First Test** – Set the date and time for the first Periodic Test.
- **Period** – Set the interval between two Periodic Tests. The interval can be set from 1 up to 25 hours, in steps of one hour. The default setting is 24 hours.

 *The Periodic Test event IS NOT recorded in the Events Log.*

The section **ADDRESS BOOK**  programs the telephone numbers which can be used to send:

Voice Messages (Dialler function) and **Telemonito-**

ring data when the events, recognized by the panel, will occur.

In the case of **Telemonitoring**, select: the type of protocol (SIA, ADEMCO Contact ID) and Customer Code.

Phone numbers are:

- only for alarms;
- only Faults,
- and numbers of general use.

In the section **VOICE MESSAGES** , parameters relating to voice messages are programmed, as described below.

(1-7) MESSAGES – These messages (from 1 up to 7) are NOT editable.

(8-32) MESSAGES – In this section, a description of 20 characters max, can be assigned to messages from 8-32.



listen a present message.



stop the message playback.



delete the selected message.



a voice message can be recorded via the microphone on the PC (max 6 seconds, Header message 12 seconds).



imports an audio file (mp3, wav) to be used as a voice message (max 6 seconds).

 *The USB memory stick is the ONLY way to download in the panel the AUDIO files*

IP interface The **IP interface** section is active after the module FC500IP has been enabled in the **General Options** page (Figure 26). The IP module programming is in 3 sections: **OPTIONS**, **ADDRESS BOOK** and **ADVANCED**.

OPTIONS:

DHCP – Select this option if you wish to use a dynamic address for the IP Module you are programming.

- **IP static**– Select this option if you wish to assign a static IP address to the IP Module you are programming and set the following parameters:

- **IP address:** enter the IP address to be assigned to the IP Module. The network administrator will provide you with this information. The default setting is 192.168.0.101.

- **Subnet mask:** this must be the same as the subnet mask for the local network. Only one subnet mask is valid for each local network. All nodes on the same subnet will use the same subnet mask. The network administrator will provide you with this information. The default setting is 255.255.0.0.

- **Gateway IP address:** enter the IP address of the local gateway which may be used by the IP Module to connect to a PC outside the LAN (WAN). The default setting is 0.0.0.0.

Ethernet speed

This section is used to set the parameters corresponding to the Ethernet interface of the IP Module. The Auto setting is selected by default.

➤ **Auto** – If this option is enabled, the IP Module will take the speed and duplex values from the network. If this option is disabled, the speed and duplex values must be set as described below.

➤ **Speed** – If the Auto option is disabled, set the speed value as appropriate: **10 Mbps** or **100 Mbps**.

Duplex – If the Auto option is disabled, set the Data exchange (Duplex) mode as appropriate: **Half** or **Full**.

Read-only options

The values in this section cannot be modified. They display information relating to the connected IP Module.

➤ **MAC Address** – Displays the MAC address of the IP Module: the MAC address is a unique identification number assigned to every IP device throughout the world.

➤ **Firmware version** – Displays the version of the program running on the IP Module.

➤ **Boot version** – Displays the boot version.

Current IP address – Displays the IP address assigned to the IP Module.

General options This section is used to select the general options for the IP Module.

Encryption key – If it has been programmed, the IP Module will use this key to encode and decode the packets exchanged with the PC. The encryption key may include between 1 and 32 hexadecimal characters (numbers 1 to 9 & letters A to F). To disable encryption, enter 0 (zero). If the encryption key does not correspond to that of the IP Module, communication between the PC and the IP Module will NOT be permitted. The default setting is 0 (encryption key not enabled).

Board port – This is the port which should be used to communicate with the IP Module. The default setting is 3064.

Pass Through port – This port should be used to communicate with the control unit. The default setting is 3062.

Board code – This code should be applied when the FireClass Console is used to program the IP Module, either remotely or locally. The code should consist of 4 hexadecimal digits. The default setting is 5555.

Idle Connection Timeout – Enter the maximum time period during which no data is transmitted before the connection is terminated. The default setting is 20 seconds.

ADDRESS BOOK

Account Code – The account number is used by the central station to distinguish between transmitters. There is one account number programmable for the FC500IP. Default value: (0000FFFFFF).

 *Account codes 0000FFFFFF,FFFFFFFF and 0000000000 are not valid accounts.*

➤ **Supervision**-To enable Supervision mode, tick this option.

Main

➤ **IP_Address** – Static IP address for the receiver. Program the IP address of the central station receiver. If an IP receiver is not connected program 0.0.0.0 address. Default value: 000.000.000.000.

➤ **Local Port** and **Remote Port** – These values show the ports to communicate with receiver. The same receiver supplies these values. Default values:3060 (**Local Port**) and 3061 (**Remote Port**).

Backup

- **Receiver IP** – Static IP address for the second receiver. Program the IP address of the second receiver. Default value: 000.000.000.000.

 Receiver will be used for backup only; not checked.

- **Local Port** and **Remote Port** – These values represent the ports used for communication with the backup receiver. Default values: 3065 (**Local Port**) and 3066 (**Remote Port**).

Third

- **Receiver IP** – This is the IP address assigned to the receiver of the domotics system with which you wish to interact. It is supplied by the receiver itself. Default value: 40000.

Local Port and **Remote Port** – These values represent the ports used when communicating with the domotics system receiver. They are supplied by the receiver itself. Default value: 40001.

The receiver will be used for the domotics system only; not checked.



ADVANCED





LED Trouble mask / Output Trouble mask.

This section can be used to enable/disable signals from the OC output and the indicator light, for certain events recognised by the IP Module: **Network Absent**.

A tick indicates that the corresponding event will be signalled. The LAN not detected event indication is enabled by default.

Output polarity. This section is used to set the operating mode of the OC output on the IP Module.

- **Open on trouble** – The outlet is suspended when a breakdown occurs (default setting).
- **Close on trouble** – The output is connected to the earthing system when a breakdown occurs. For the IP module, the procedure to “restore to the factory defaults”, use the  icon in the **Advanced** section. In the same section, **Advanced**, you can upgrade the firmware  and to reset the FC500IP board  . For an explanation of the further parameters and the programming, see the dedicated manual of the FC500IP module.

Events In this section  , for each event recognized by the Panel, it is possible to program the following: the telephone numbers to call, the Voice Message and the Events code to be sent. The Alarm, Delay to Alarm, Warning, Fault and Walk Test events can be sent to up to 32 telephone numbers . The telephone numbers are set in the ADDRESS BOOK section  . It is also possible to set the type of phone call: Voice  , Telemonitoring  , or IP communicator  .

Options for using the voice messages:

- 1) record them directly on PC or import present messages on the PC using the functionality of the buttons in the **Messages** section.
- 2) import them on PC from an external source, for example, a USB stick and upload them, using the functionality of the buttons in the **Messages** section.

 To load the voice messages in the Panel, it is necessary to use the USB connector on the motherboard and to start the Programming procedure of the Panel by User Interface (see Programming from the Panel, 7 KEY -USB-.)

Clock

The Date/Time option from the CLOCK menu is for the control panel clock settings.

Enter the required Time and Date.

Schedule the automatic application of summer time if required. The button  will change the daylight saving to the default values.

Log

This option displays the Log stores events.

Description of the icons in the LOG bar:

 Upload from Board: uploads the LOG of the connected control panel.

 Export LOG to file: exports the LOG in a (*.fcl) or (*.xml) or (*.xmc) file.

 Import LOG from file: import the LOG from a (*.fcl) or (*.xml) or (*.xmc) file.

 Apply filter: selects the LOG filter (if necessary):

- Enabled/Disabled/Restore/Alarm/Delay to Alarm/Warning /Fault/Generic/Walk test

If required set other filters for the Event Log:

- Filter by panel/Filter by Loop/Filter by device /Filter by zone.



 Print a text file: prints the control panel Event Log, or part of it.

The following data will be stored in the LOG: the Event's **Number**, the **Date**, the **Time**, the **Class** (Fault, Alarm, Warning, Generic and Walk test), the **Event's description**, the Control panel **number**, the **Loop**, the **Device type**, the **Status**, the **Threshold** and the **Zone**.

Selecting this icon  deletes the Event Log.

Utilities

The following functions are located on the **Utilities Page**:

-  - checking Battery Calculations (see next dedicated paragraph).
-  - using a USB stick both to load the firmware, voice messages, panel programming, then  download the data of a customer.

 *By clicking on "Override", it is possible to adjust the panel ID for export/import. If the option "Any Panel [XXXX]" is implemented, it is possible to utilize this configuration in any Panel (e.g. to load same voice messages in several panels)*

 - loading the label of the first 8 zones, which should be printed and inserted in the transparent window in the User Interface (see Description of the parts).

 - printing a pdf file which contains descriptions of the first 8 zones. The size of the front label is predetermined and can not be resized (see Figure 27).

 *In the Printer driver, set the "Page resizing" option to "None"*

 - importing the type of wiring (from a database) for use in various connections Loop. These type of wires will be used in the **Loop wire calculation** (see same paragraph).

 *The database can be moved from one system to another. The Console searches for the wire database while starting. If the user cannot access a moved database, simply close the software and restart.*

■ Battery Calculation

The Battery calculation window allows you to see (Figure 28):

- the FC501 Loads,
- the Loop1, Loop 2, Loop3 devices loads, in the condition of **Normal Load** and **Alarm Loads** (percentage of devices in alarm status), when the Mains fails. Below this window, in the option "Others Load", if needed, the Loads on Auxiliary terminals will be inserted. Automatically the **Total Load**, the **Battery needed** and the **Battery Recharge Time** will be shown. Set the **Stand-by hours**, **Alarm minutes** values and the calculation will be done.

Battery calculation Parameters:

- Stand-by hours (From 1 to 144 h)
- Alarm minutes (From 1 to 240 m)

Battery Type: this is the battery (Ah) arising from calculation.

Battery calculation constraints:

- Lock stand-by hours
- Lock battery type.

Lock stand-by hours: "Battery Type" value (Ah) will be calculated, fixed **Stand-by hours**, **Alarm minutes**;

Lock battery type: "Stand-by hours" value will be calculated, fixed **Battery Type** (Ah), **Alarm minutes**.

 *The software calculation is a rough calculation and cannot substitute the Installer and/or Qualified person calculation.*

 Exports the battery calculation into a .CSV file that can be opened by Excel or a similar application.

Figure 27 Page to print the zones label.

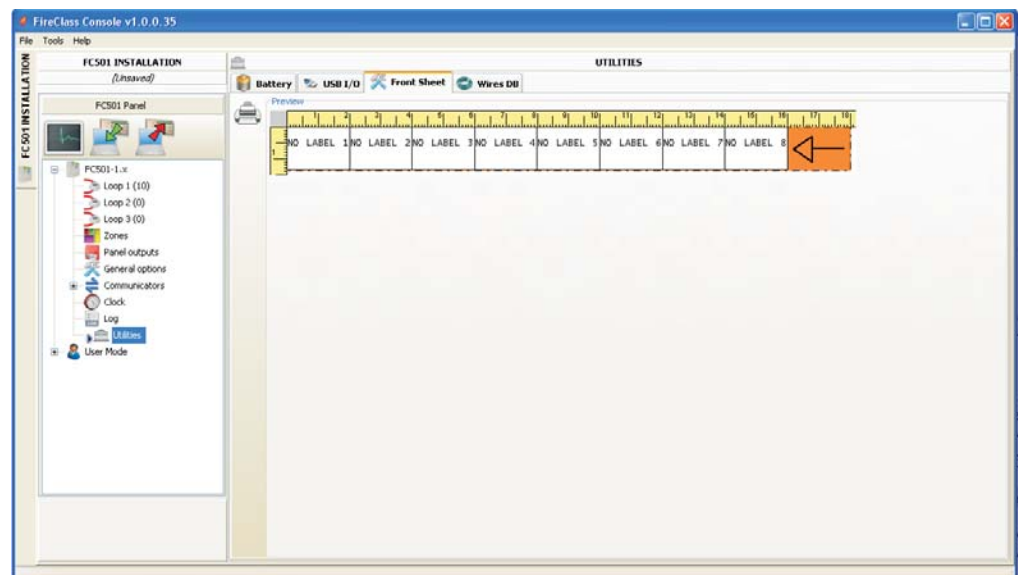
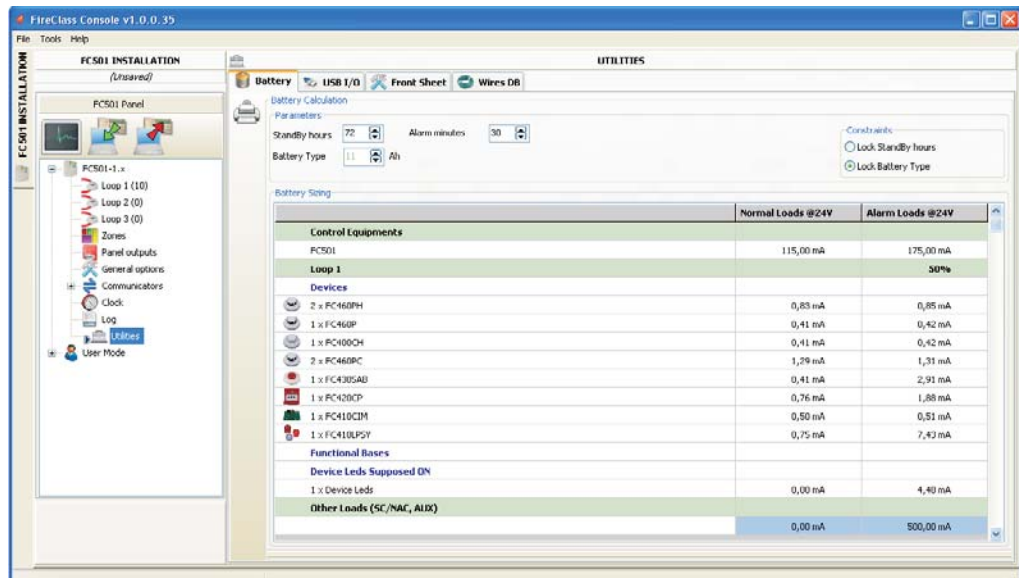



Figure 28 Utilities window



User mode

If the option "Installer Mode" is enabled, it is now possible to program/ change the installation, using the Installer password. If the option "User Mode" is enabled, this feature allows the user to perform the real time monitoring of the panel zones and the loop devices associated with them. The loop device or zone is displayed in a way that immediately informs the user about its state with a coloured background, an overlapped icon, etc. Selecting the loop device, the user can also receive real time information about the last measured value (that can be expressed in °C, ppm, %, V, etc., depending on the device type).

While the FC501 Console is running, the user can choose whether to work in **Normal mode** of communication (communication with the panel takes place only when required), or in **Real Time mode**.

The communication in Real Time mode is activated by the button , and starts a session of continuous communication with the control panel.

While the FC501 Console is in Real time mode, it constantly receives data from the panel, and provides the user with feedback on the changes of status of the control panel. The communication in Real Time mode provides the user with two additional controls: **Events in real time**, and **Remote control**.

The **Event log** in real time is similar to that found in the "Event Log" page, but it is updated constantly, and always shows the last 16 events generated by the control panel. The **remote control** panel is used to send commands

to the Fire Panel as if a graphical interface were being used. This feature allows the user to remotely press the functional buttons that are present on the panel user interface: Silence, Reset, Investigation, Lamp test, Silence Buzzer, Evacuate. Sending a remote command to the panel through this interface will require the SW User to insert the panel's User or Installer password for security reasons.

A control keypad will request the password when commands are sent to the fire panel. The remote control panel also shows the detailed status of the connected fire panel, and provides a ready visualization of status changes.

A second click on the button  ends the communication in real time mode and returns to normal mode.

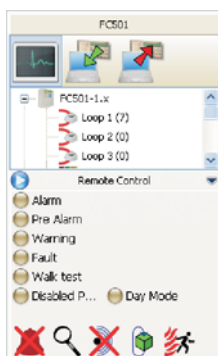





Figure 29 Remote Control display

■ Graphic Maps

The User mode provides the use of Graphics Maps. The activation procedure follows.

1. It is necessary to create the tree structure to contain the Graphics map. Click on the icon  and define the first map/background, click on the icon  to import it.



 *The system of **Graphic maps** allows the use of vector graphics file (WMF) as well as the more traditional bitmap formats (BMP, JPG, GIF, PNG).*

This is the map that will be shown in the condition of absence of events.

2. Do the same for other levels of maps and insert in each node of the tree structure its plan (e.g. the picture of the building, the floor where the system is installed and the installation plan).
3. Use the icon  to delete any map/structure.
4. Insert the devices on the maps; after the map has been selected, click on the name of the installation, in the same window, under the tree. A list of all devices on the loop will be shown. At this point it is sufficient to drag the selected device in the relevant position on the map in question.
5. The final map consists of a series of separate pages linked together and easily accessible or by accessing to the tree diagram.

 *The Graphic Map, in Real time, is shown in a dedicated window. It is possible to analyze more than one device at a time, but each new image requires additional system resources. To analyze more than four devices simultaneously is inadvisable*

In Real-time mode, the Graphic map is normally shown in stand-by status (first map/Background).

6. When the fire panel detects and reports a changed status of detector or module, the FC501 console replaces the icon of the detector with the icon of the event (Fire Alarm, Fault, etc.).
7. The FC501 console activates the Graphic map where the detector/module has changed status. Through the connection between the activated map and the first map/background of higher level, the area associated will blink.
8. Use the icon  to realize the drawing of possible areas, that will blink when the contained devices will be activated. To close the area: a double click using the Dx button.
9. Use the icon  to delete any devices or areas, after they are selected. For more info about the functioning and use of Graphic maps, follow the Help, accessible both by main menu and by the Graphic maps.

■ Disable

The disable page (click the right button on the selected device) is available only when the FC501 Console communicates in Real Time.

The items that can be disabled/enabled are: devices, zones.

Before sending a Disable/Enable command, the FC501 Console provides the prompt to enter the User password.

Figure 30 Example of the graphical maps

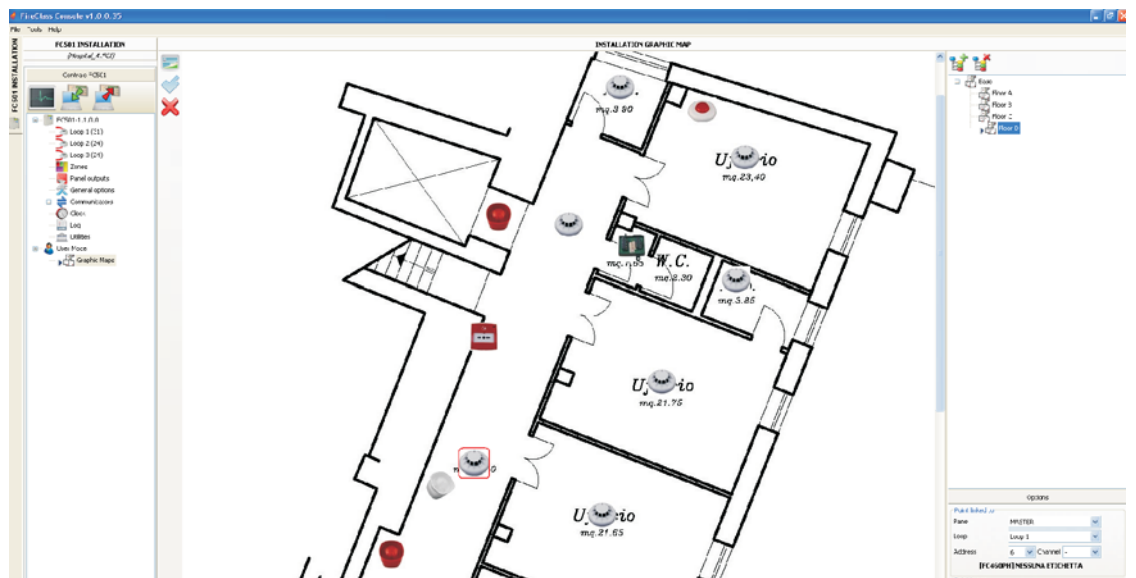

PROGRAMMING FROM THE PANEL

The following section provides an overall view of how to use the User interface Programming (Main panel) of the control panel. For details regarding the parameters of each phase, refer to the respective paragraph in the "PROGRAMMING FROM A PC" chapter.

Using the system

The FC501 system can be managed from the User interface (main panel) and/or through the FireClass Console application. The User interface (main panel) allows access to different authorized Level.

There are three different access levels which include:

L1= First Level: this level allows the Reading of Parameters ONLY:

-**ANALYZE** button **views** the status of the: LOOP, DEVICE, SW ZONES, OUTPUT, NETWORK, TELECOM, OPTIONS, LOG, FW Vers., and PANEL;

-**View LOG;**

-**View Lists** button **views** the lists of: DIS. ZONES, DIS. DEVICES, DIS. PARTS, WALK TEST, FAULTS, WARNINGS and Dev. in TEST.

L2= Second Level or USER Level: access to this level requires entry of the USER PIN (Access Level 2).

This level allows all the operations of the First Level, but also allows you to **MODIFY**:

-**MODIFY** button for: Init MSG (MESSAGE), L2 USER PASSWORD, DAY/NIGHT, TIME and DATE, CLEAR LOG and WALK TEST;

-**DISABLE** button for: DIS LISTS, DEVICE, SW ZONES, OUTPUT, NETWORK, COMMUNIC., FIRE RELAY, SOUNDERS;

L3= Third Level or INSTALLER Level: access to this level requires entry of the INSTALLER PIN (Access Level 3).

This level allows all the operations of the First and Second Level, but also allows you to program the system; the Programming phase allows the installer to program the control panel and peripheral devices (detectors, modules, repeater), in detail:

AUTO, DEVICES, SW ZONES, OUTPUTS, NETWORK, MAP DEVICE, USB, SYSTEM, DEFAULT and PWD L3.

Operating the system from the Panel

To manage the system from the User interface (Main panel), the Alphanumeric keypad, the Cursor keys, the ESC Key & the ENTER key are used.

 The use of the keypad, cursor keys, ESC key & Enter key is explained in detail in the following sections.

■ Alphanumeric entry (Editing text)

Use the Alphanumeric keypad to create labels and enter data and codes.

The string must be 20 characters max.

Alphanumeric keypad Each time the alphanumeric key is pressed in the selected position, pointed by the cursor, the characters printed on the key will appear in sequence and cyclically.

Key	Sequence
1	ABC1
2	DEF2
3	GHI3
4	JKL4
5	MNO5
6	PQR6
7	STU7
8	VWX8
9	YZ blank 9
0	blank 0

 By long pressing the "0" key, the entered data will be cleared and the cursor will return to its starting point.

Cursor keys Use the **UP** key for upper-case letters and the **DOWN** key for lower-case letters.

Use **LEFT** and **RIGHT** keys to scroll along the line, then press the alphanumeric key to insert in the selected position.

ENTER key Once the text has been completed, press the **ENTER** key to confirm and step forward, or in the main page signaling a local programming activity followed by a panel reset.

ESC Key The **ESC** key is used to cancel the operation and to step back to previous page.

 For additional functionality about the keys use, see the User Manual, Chapter "User Interface".

 The following pages show all possible operations managed at **Level 3 (Installer Level)**. The operation managed at **Level L1 and L2 (User Level)** are shown in the User Manual.

Assistant text composition

To make the entry of text strings easier, an assisted procedure has been included, based on a pre-compiled list of 128 words (18 char max) vocabulary. When one of the numeric keys is pressed to enter a letter, the first word in the list which begins with that letter will be inserted. The up and down arrow will, respectively, load the next or the previous word in the list. This "assisted entry procedure" is entered by keeping the UP key pressed for more than 3 seconds, while pressing the DOWN key for more than 3 seconds will deactivate the "assisted entry procedure" and the normal single character entry is reactivated (see Figure 32). When the "assisted entry procedure" is active, the string "Vocabulary ON" blinks on the upper right area of the LCD display. In the "Vocabulary area" the word currently selected (row aligned with the "Entry area") is displayed. The word that precedes in the vocabulary is displayed in the upper row while the next word is displayed in the lower row. In the "Entry area" the words used to compose the label are displayed. To enter a word it is necessary to press the numeric key (more than one time if necessary) related to the first letter of the word that needs to be entered. If this word is not correct, it is possible to scroll through the vocabulary using the UP and DOWN keys until a suitable word is found. During the vocabulary scan, the word in the middle row is entered in the "Entry area" at the cursor position. Using the LEFT and RIGHT keys it is possible to move the cursor to the beginning of each word.

■ Single Selection

This is normally used to select a single value between a set (max 8) of possible values.

ON off
^

The selected value is displayed in Upper case. The selection of a further value will automatically deselect the previous selected value. In this phase:

Alphanumeric keypad No function is related to Alphanumeric keypad.

Cursor keys Up key: No function is related to **UP** key

Down key: No function is related to **Down** key;

Right key: Moves the cursor to the next value position and select the value pointed;

Left key: Moves the cursor to the previous value position and select the value pointed.

ESC Key: Use **ESC** key to cancel the operation and to step back to previous page.

ENTER key: Accept the programmed string and the User

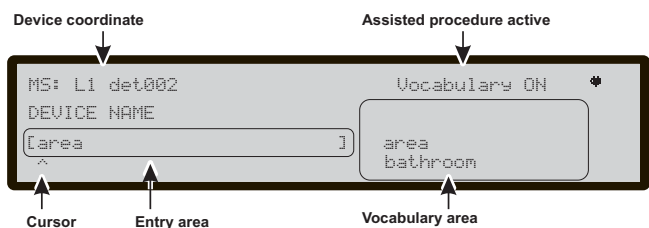

Figure 32 Assisted entry procedure.

Interface moves to the next programming parameter page, if any, otherwise returns to the main page signaling a local programming activity followed by a panel reset.

■ Multiple Selection

This is normally used to select more than one value between a set (max 8) of possible values.

SUN mon tue wed thu **FRI SAT**
^

The selected value is displayed in Upper case.

In this phase:

Alphanumeric keypad No function is related to the Alphanumeric keypad.

Cursor keys Up key: select the value pointed by the cursor.

Down key: deselect the value pointed by the cursor;

Right key: Moves the cursor to the next value position and select the value pointed;

Left key: Moves the cursor to the previous value position and select the value pointed.

ESC Key: Use **ESC** key to cancel the operation and to step back to previous page.

ENTER key: Accepts the programmed string and the User Interface moves to the next programming parameter page, if any, otherwise returns to the main page signaling a local programming activity followed by a panel reset.

■ Date and Time

This is normally used to enter the time and date in the following format:

hh: mm: ss dd/mm/yy
^

Above is the default time format. It is possible to select an alternative time format displayed below:

hh: mm: ss mm/dd/yy
^

In this phase:

Alphanumeric keypad Used to enter date and time numeric value.

Long pressing the "0" key will clear all entered data

■ Cursor keys

Up key: No function related to **UP** key

Down key: No function related to **DOWN** key

Right key: Moves the cursor to the next digit position;

Left key: Moves the cursor to the previous digit position;

ESC Key: Use **ESC** key to cancel the operation and to step back to previous page.

ENTER key: Accept the programmed string and the User Interface moves to the next programming parameter page, if any, otherwise returns to the main page signaling a local programming activity followed by a panel reset.

■ Numeric entry

Normally used for enter numeric data up to 20 digit.

[]
^

In this phase:



Figure 33 Wrong value display.

Alphanumeric Keypad Used to enter digit.

By Long pressing the "0" key, all of the entered data will be cleared

Cursor keys **UP key:** No function is related to **UP** key.
Down key: No function is related to **Down** key;
Right key: Moves the cursor to the next digit position;
Left key: Moves the cursor to the previous digit position;
ESC Key: Use **ESC** key to cancel the operation and to step back to previous page.

ENTER key: Accepts the programmed string and the User Interface moves to the next programming parameter page, if any is present. Otherwise the user interface returns to the main page signalling a local programming activity followed by a panel reset.

To program each parameter or option inside the system, the same page will be used that can adapt itself to the most appropriate program mode for the parameter to program.

In the case of a wrong value entered, the following message will be displayed for 5 seconds (see Figure 32).

Main Page - Accessing the system

After the Control panel has been installed and powered by the Mains, when the user accesses the panel for the first time, they will be prompted to choose the language of the display, then the Main Page will be shown as per Figure 34.

In this phase:

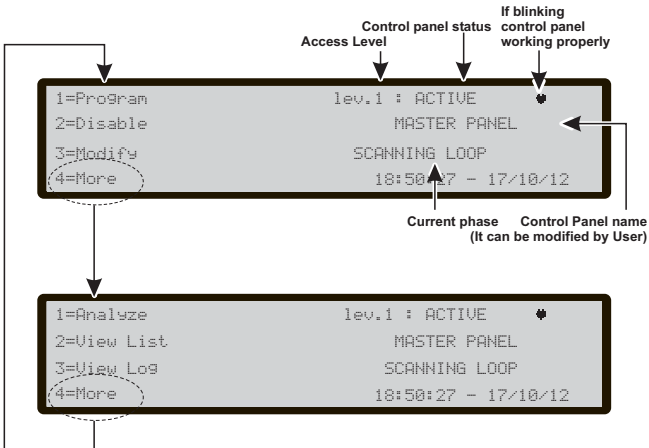

Figure 34 Main page window.

Alphanumeric keypad Key 1 displays the "Program" or "Analyze" mode;
 Key 2 displays the "Disable" mode or "View List";
 Key 3 shows the events of the LOG or displays the "Modify" mode;
 key 4 selects between groups of related functions of the keys 1,2, and 3.

Cursor keys The **UP** Key: increase the brightness of LCD display;
 the **Down** Key: decrease the brightness of LCD display;
 the **Right** Key: increase the contrast of LCD display;
 the **Left** Key: decrease the contrast of LCD display.

ESC Key Exit from the main page, moves the User Interface to Front page or event driven page, if any. By pressing the key for more than 3 seconds, the panel will be forced to access level 1.

ENTER Key No function is related to ENTER key.

When the panel starts its normal activity and no accesses to the User Interface are sensed for a period of 30s, the User Interface leaves the Main page and reaches the Front page. For more features see the description of the MAIN page in the User Manual.

Insert password

From the **MAIN** page, by selecting 1 key "**PROGRAM**", the panel will prompt the Installer password to operate at Level 3;
 the **default** installer code is **00000**: every digit will be hidden by *(star) symbol.
 in this phase (see figure 35):

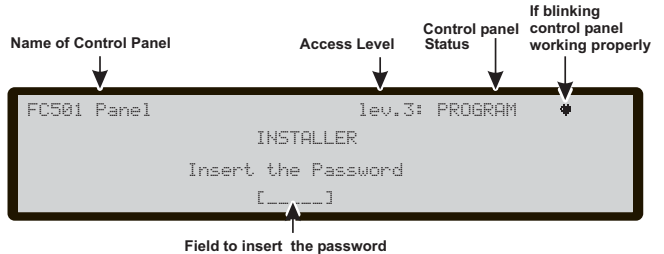

Figure 35 Insert password (Installer code).

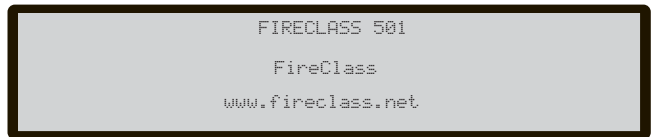

Figure 36 Front page window.

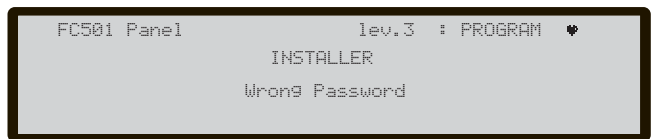

Figure 37 Display Wrong Password.

Alphanumeric keypad Use the Alphanumeric keypad to insert the **5-digit** password.

ENTER key Accepts the password and starts the password verification process. If a Password is wrong or missing, the screen shown in Figure 37 will appear.

To return to the previous screen, press the Esc key or wait 5 seconds.

Cursor keys No function is related to **UP**, **Down**, **Right** and **Left** keys.

ESC Key If the entry field for the password is empty: abort the enter password procedure and move back to the User Interface to calling page, otherwise clear the entered digits (clears the entry field).

Programming Page

From the MAIN page, use the **1** Key to select the Programming phase. Insert the password (installer code) and then the page (Figure 38) is shown.

Alphanumeric keypad Use the Alphanumeric keypad to select the different programming functions:

0= L3 PWD; start the page to insert the password of L3 level (Installer code) (see **Insert-Modify password** page);

1= Auto: start the auto-learning of the loop devices and the RS485 network devices (Repeater only).

2= FC Dev: start the selection and programming page of the loop devices.

3= SW Zones: start the programming page of the software zones.

4=Outputs: start the programming page of the Outputs;

5= Network: start the programming page of the RS485 network, FC500MFI modules.

6=Map Device: activates the "On Demand device mapping" feature.

7=USB: start the programming page for the management of the USB memory stick.

8=System: start the programming page of the system parameters.

9=Default: forces a default setting restore procedure.

Cursor keys No function is related to **UP**, **Down**, **Right** and **Left** key.

ESC Key Use **ESC** key to cancel the operation and to step back to MAIN page.

ENTER Key No function is related to **ENTER** key.

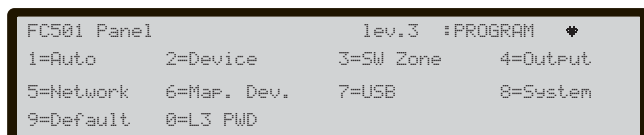

Figure 38 Program Page window.

0 KEY - Insert Modify password

On the PROGRAM page, press the **0** key for the display (see figure 39). In this phase: Installer Code at Default is 00000; every digit will be masked by * symbol.

See the Installer and User features in relation to the password.

Alphanumeric keypad Use the Alphanumeric keypad to insert the 5 digit password. The first digit must be **0** for the installer 1 (Main Installer) and **9** for the next one.

The panel will verify the correct entry of the identification digit. In the case of an error, a denial tone is generated

Cursor keys No function is related to the **UP**, **Down**, **Right** and **Left** keys.

ESC Key Short press: aborts the enter password procedure and moves back the User Interface to calling page; Long press: clears all the entered digits.

ENTER key Accepts the password and starts the password verification process.

If the password is incorrect, Figure 37 will be displayed for 5 seconds.

To avoid entering a duplicated password (two different users/installers with the same password), the users and installers are driven to use a specific digit as the first digit of their password. In this way the most significant digit acts as user/installer identifier.

The first digit for USER #1 is: 1

The first digit for USER #2 is: 2

The first digit for USER #3 is: 3

The first digit for USER #4 is: 4

The first digit for USER #5 is: 5

The first digit for USER #6 is: 6

The first digit for USER #7 is: 7

The first digit for USER #8 is: 8

The first digit for INSTALLER #1 is: 0

The first digit for INSTALLER #2 is: 9.

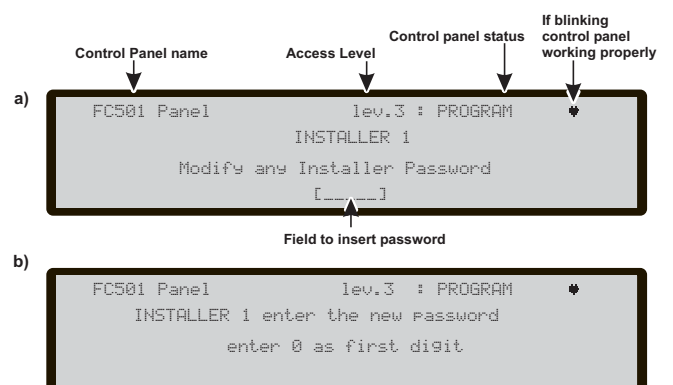

Figure 39 Insert/Modify Password window.

1 KEY- Auto Enrolling (Autolearning)

The **Auto** option from the **PROGRAMMING** menu will allow you to enrol the loop devices and the RS485 network devices automatically (repeater FC500REP only). The **Auto** option consists of three main phases: 1-Auto enrolling, 2- Auto addressing, 3- Devices mapping.

Auto enrolling (Autolearning) can be done during the installation phase and after changes of the loop and network configurations.

Use the **1 Key** to select **Auto** option, the display will show Figure 40

Alphanumeric keypad No function is related to Alphanumeric keypad.

Cursor Keys No function is related to **UP, Down, Right, Left** Key;

ESC Key Use **ESC** key to cancel the operation and to step back to MAIN page.

ENTER key No function is related to **ENTER** key.

If an open circuit is detected when enrolling is launched, the installer is prompted to launch the procedure to locate the loop break. The number of devices visible on the left and right side of the loop is calculated and displayed on the LCD.

If a double address fault is detected when enrolling is launched, the installer is prompted to switch on the LEDs of the involved devices.

If the faults described above are generated in not steady situations (devices which start/stop working randomly, faulty contacts between wires, etc.) the result of the new operations could be misleading (a wrong number of devices on left or right side of the loop could be signalled, the LED of a device with a double address could remain off etc).

A new feature, "**Sounders Triggered by**", is available. It allows the user to activate the sounders on the control panel alarm or on the zone alarm by default. The enroll procedure on the control panel LCD has a new page added to it. In this page, the installer is prompted to choose whether to activate the enrolled sounders on the control panel alarm or the zone alarm.

Automatic zones assignment

After few seconds: the panel will prompt to choose the type of automatic zones assignment.

This feature allows to assign the zone to each enrolled detector, and define the first trigger zone for the activation of all outputs channels in the enrolled modules.

The possible schemes used to assigned the zones are proposed to the installer by the panel during the enroll process (see Figure 40d):

- 1 = on Loop basis
- 2 = on device address basis
- 3 = no assignment.

Three different schemes are possible:

Scheme 1): all the devices located on loop1 will be assigned to zone 1; all the devices located on loop 2 will be assigned to zone 2; all the devices located on loop 3 will be assigned to zone 3.

Scheme 2)

- From address 01 to address 16 assigned to zone 1
- From address 17 to address 32 assigned to zone 2
- From address 33 to address 48 assigned to zone 3
- From address 49 to address 64 assigned to zone 4
- From address 65 to address 80 assigned to zone 5
- From address 81 to address 96 assigned to zone 6
- From address 97 to address 112 assigned to zone 7
- From address 113 to address 128 assigned to zone 8.

Scheme 3)

All the devices found on the loop are assigned to zone #0 (system zone).

The previous zone assignment schemes are also applied to the first "trigger zone" in the case of output only devices (sounder, beacon, SNM module) or output channel of Input/output devices. After the Zones assignment is selected

For devices already addressed (1-128) the zone assignment procedure is the same as explained above (see Figure 40d). For not addressed devices, if you choose ESC at the end of Auto addressing, the panel assigns the zone based on the loop, but if you choose ENTER the panel assigns the zone based on its address.

In this phase, the Alphanumeric Keypad only is active:

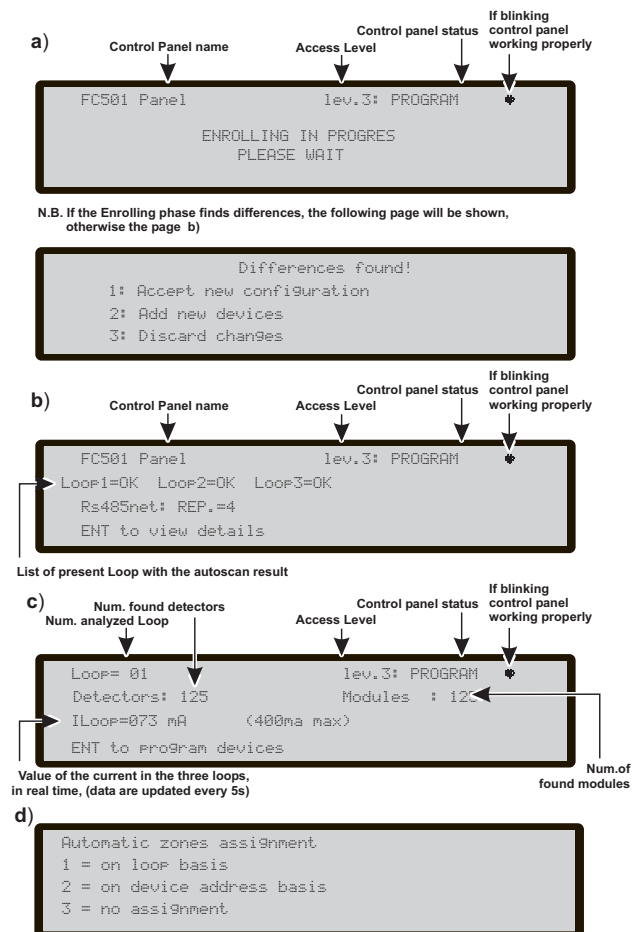



Figure 40 Autoscan results window.

ENTER Key The **ENTER** key accept the device selection and activate the loop device programming.

 *Attention: when the Enrolling is done, the devices programming data (except their assigned names) will restore to the factory defaults; therefore a previous configuration will be lost (Selection 1).*

Auto addressing procedure

Auto-addressing creates a sequence of operation that allows to the installer to make all the devices accessible by the panel without executing any previous configuration action on the devices, during their installation phase. The installer no longer needs to use the FC490ST, the programming Tool of the Loop devices, and consequently no longer needs the procedure for the manual assignment of the devices addresses. Furthermore the auto-addressing procedure must allow the installer to know or set the geographical position of the devices in the site (device mapping phase).

 *In the Program Menu of the loop devices, a new item appears. This allows the installer to switch on(steady)/off the device LED. This allows the installer to activate the device LED from the control panle User Interface in order to easily identify the device on a given field.*

The Auto addressing procedure is part of the loop devices enroll process in the FC501 panel. The loop devices enroll process is initiated by the installer:

- press the **1** key to enter in PROGRAMMING mode.
Enter the Installer PIN (00000) at default. Each digit will be masked by * (star).

- Select option 1: AUTO.

When all the devices are initialized in Loop, the panel will prompt the user to choose the type of automatic zones assignment:

1 = according to the Loop

2 = based on the addresses of the devices

3 = do not assign

When this choice is made, the user can reach the results phase by:

- pressing the **ENTER** key to activate the AUTOADDRESSING phase.
- or pressing **ESC** to the **FAULT** page (not addressable devices).

By default, any addressable device has the address 255. The fire panel examines the serial number of each device and assigns each an address from 1 to 128.

If the control panel finds a device with a different address than default (255) it leaves the address set at that device.

 *The control panel is ready to work, at this time, (with the default basic programming)*

If for requirements of the system, the installer wants to set the system (for example set the address 1 to detector 1, address 2 to detector 2, and so on), follow this procedure:

- press the **ENTER** key, so the fire panel initiates the MAPPING DEVICES phase. First phase:
- In this phase, the installer must activate in sequence, moving in the plant, all input devices: detectors, input modules, Manual Call Point, and then return in front of the fire panel.
- Report the sequence of activation on the map of system.
The fire panel will store the activation sequence (even temporarily).
The installer using the User Interface UP and DOWN key will start to examine the first activated device.
- Select the device, the address will blink, so the installer can change the address.
Press **ENTER** to confirm and the address will become fixed.

 *If the ENTER key is pressed again, the installer can switch to programming phase of the device in question.*

"Unique", indicates that it is the only device of its type on the loop. It is not necessary to activate it and the installer knows where it is.

Second phase:

In this phase, the installer examines the sounders, the beacons and the output module.

- When the installer, scanning the list of previously auto-addressed devices, reaches an output-only device type, this device becomes active (a sounder starts to sound, a beacon starts to flash, an output module illuminates its LED) until a new device is selected or the permanent address is entered.

In this way it is possible to locate where the device is.

 *The enroll process does not take place until all loop wiring troubles have been removed.*

 *The auto-addressing procedure has to be used when on the loop there are NG1 devices, otherwise it doesn't have effect.*

 *The device mapping process does not take place until all double address faults have been removed*

2 KEY -Device

The **Device** option in the PROGRAMMING menu activates the screen used to select and program the devices on the loops (see figure 40).

■ Choose the Loop (see User Manual View Devices)

In this phase:

Alphanumeric keypad Press 1, 2 or 3 for the relevant loop.

Cursor Keys No functions are related to the **UP** Key. No function is related to **Down** Key. The **Right** key selects the next available Loop. The **Left** key selects the previous available Loop.

ESC key : The ESC key deletes the procedure and returns to the previous page;

ENTER The ENTER key accepts the selection and activates the corresponding programming page. Regarding figure 42, the “selected device” field shows the currently selected device. The “Add ” field is used to enter the address of the selected device. The scroll bar of available devices shows the addresses and the class of all devices configured in the selected loop. d087 address of the device (three digits); class of device: d = detector, m = module. The scroll can be viewed by using the cursor keys or entering a device address in the “Add ” field.

In case the address entered does not exist, the scroll bar moves to the next available address.

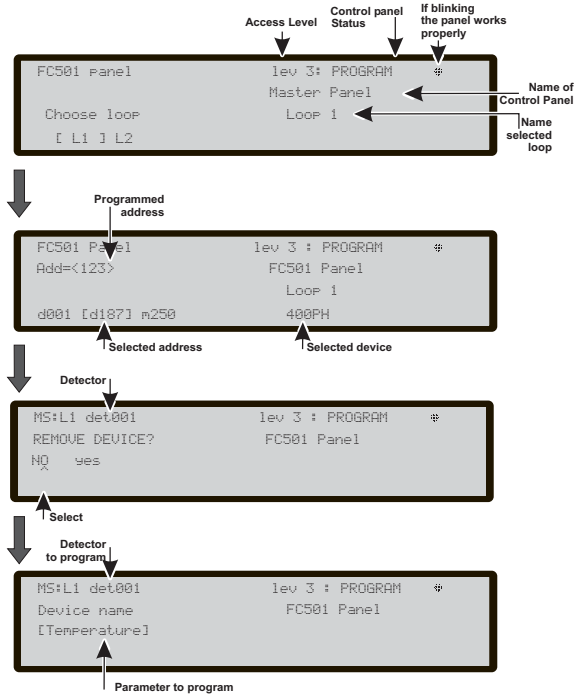

Figure 42 Pages of Selecting and programming Devices on Loop.

■ Choose the Device

In this phase:

Alphanumeric keypad Used to enter the address of the selected device. if the address does not exist, the next device available is selected.

If the device exists, square brackets will appear next to the address, but if the entered address does not exist or is different from the one selected in the bar below, arrows appear.

Cursor Keys No function is related to **UP** or **Down** Key. The **Right** key selects the next available device. The **Left** key selects the previous available device.

ESC Key The **Esc** key deletes the procedure and returns to the previous page.

Heat detector	Smoke detector	Smoke + Heat detector	Heat + CO detector	Heat+Smoke + CO detector
Remove device? <u>No</u> Yes	Remove device? <u>No</u> Yes	Remove device? <u>No</u> Yes	Remove device? <u>No</u> Yes	Remove device? <u>No</u> Yes
Working mode: DAY: <u>A2S</u> CR A1R		Working mode: DAY: Temp= <u>A2S</u> A1R DIS	Working mode: DAY: <u>CO=Default</u> Enhanced Disabled	Working mode: DAY: <u>Universal</u> High Immunity
Working mode: NIGHT: <u>A2S</u> CR A1R		Working mode: NIGHT: Temp= <u>A2S</u> A1R DIS Smoke= <u>Default</u> Enhanced Disable	Working mode: NIGHT: <u>CO=Default</u> Enhanced Disabled	Working mode: NIGHT: <u>Universal</u> High Immunity
		Working mode: DAY: <u>Smoke=Default</u> Enhanced Disable	Working mode: DAY: <u>Temp= A2S</u> A1R DIS	
		Working mode: NIGHT: <u>Smoke=Default</u> Enhanced Disable	Working mode: NIGHT: <u>Temp= A2S</u> A1R DIS	
Detector label	Detector label	Detector label	Detector label	Detector label
Assigned zone	Assigned zone	Assigned zone	Assigned zone	Assigned zone
Detector base <u>Standard</u> Isolator Relay Sounder Addressable	Detector base <u>Standard</u> Isolator Relay Sounder Addressable	Detector base <u>Standard</u> Isolator Relay Sounder Addressable	Detector base <u>Standard</u> Isolator Relay Sounder Addressable	
Callpoint	Generic Module	DDM Module		
Remove device? <u>No</u> Yes	Remove device? <u>No</u> Yes	Remove device? <u>No</u> Yes		
Callpoint label	Module label	Module label		
Assigned zone		Detector type <u>CNV</u> conventional <u>GSO</u> 4-20 mA source <u>GSI</u> 4-20 mA sink		
	Channel to program	Channel to program		
Generic digital input channel (loop devices)	Generic digital output channel (loop devices)	DDM input channel		
Working mode: <u>B</u> NO C NO C NC				
Input label	Output label	Input label		
Assigned Zone	Trigger Zone # 1	Assigned Zone		
	Trigger Zone # 2			
	Trigger Zone event <u>ALA</u> Alarm DLY Delay to alarm WAR warning FAU fault TST Test DK Double Knock			
	Silenceable <u>On</u> Off			
	Trigger Zone # 3 Trigger Zone # 4 Trigger Point # 1 Trigger Point # 2 Trigger Point # 3			

Table 9 Values table of the programming devices
Note: The underlined options are the default options.

ENTER Key The **ENTER** key accepts the selection and activates the corresponding programming page.

■ **Loop devices programming page**

After selecting the Loop and the device, (see the Figure 42) the option "LED(skip=skip test)" is displayed. This option allows for the location of the selected device in the site, lighting its LED when the option "ON" is selected (note that the ENTER key has to be pressed to make the selection valid). If the device has no LED, its sounder or beacon will be activated. The option "OFF" removes the device signalling. The option "SKP" exits the feature and moves to the normal device programming sequence where it is possible to program various parameters relevant to the type of device. See Table 7.

Remote LED After other parameters, it is possible to enable the activation of programmable **Remote LED** of the detectors. The detectors have an output used to drive the remote LED. This output is activated only for the detector alarm to which it belongs. Now, it is possible to program it to activate for other events, exactly as it happens for the other panel outputs, as well as for the detector alarm to which it belongs.

☞ *With this option (Remote LED), it will be possible to also program on FireClass Console, in the programming page of the detectors.*

■ **Separated programming of the Sounder and Beacon**

When one of the following devices is selected:

FC410LPAV (all versions)

FC430LPASB

FC430SAB (with **FC430SB**),

In addition to those certified EN54-23:

FC410LPS-R/W

FC410LPBS

FC430LPBSB,

In the programming menu, it will be possible to choose which channel (Sounder or Beacon) to be programmed. The User interface will ask the installer, before the alarm conditions:

"SOUNDER = BEACON"

"yes no"

If the installer chooses "yes", the alarm conditions are selected (and applied to both channels), otherwise the channel selection will be displayed (therefore the alarm conditions are valid for the selected channel).

☞ *See "PC PROGRAMMING" FireClass Console paragraph "Output module parameters programming"*

3 KEY - SW zone

The **SW zone** option in the PROGRAMMING menu activates the screen used to select and program the Software zone (see figure 41).

The Alphanumeric keypad The Alphanumeric keypad is used to select the zones number (ID).

Cursor Keys No function is related to **UP** and **Down** Keys.

The **Right** key selects the next available SW zone.

The **Left** key selects the previous available SW zone.

ESC key The **ESC** key deletes the procedure and returns to the previous page.

ENTER Key Accept the SW zone selection and activate the loop device programming page, if the SW zone exists, otherwise the following warning page is displayed for 5 seconds: "WRONG VALUE! enter the parameter again".

After 5 seconds the User Interface returns to the chosen SW zone pages.

ZONE NAME It is possible to enter the zone label (20 characters maximum) using the alphanumeric entry (editing text) procedures.

■ **SW zone in WALK TEST**

After selecting the SW Zone, you can able to enable or disable the option Zone in WALK TEST (OFF) or not (off).

➤ if the option All Devices (**ALL**) is selected, all the devices assigned to zone in WALK TEST mode, will NOT generate alarm in the case of their activation but they will reach the TEST status.

➤ If the option detector (**DET**) is selected, only the detectors assigned to zone in WALK TEST mode, will NOT generate alarm in the case of their activation but will reach the TEST status.

➤ If the option call points (**CP**) is selected, only the call-points assigned to zone in WALK TEST mode, will NOT generate alarm in the case of their activation but will reach the TEST status.

The presence of a zone in WALK TEST mode is signalled by the TEST yellow LED on the User

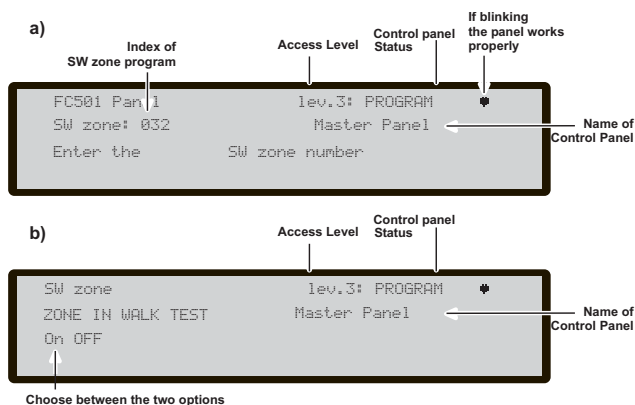

Figure 43 Pages of Selecting and programming of SW zones.

Interface. More than one zone can be put in WALK TEST mode at the same time.

Cursor Key No function is related to **UP** and **Down** Keys. The **Right** key: selects the following ON-OFF-ALL-det-cp. The **Left** key: selects the previous ON-OFF-ALL-det-cp.

ESC Key ESC key deletes the procedure and returns to the programming page.

ENTER key The ENTER key accepts the selection and activates the corresponding programming page

■ **Sounders on (3s)**

If YES, every test event (input activation) activates the sounders in the same zone for 3 seconds.

■ **Smoke delay (60s/30min)**

For each zone, it is possible to program the delayed activation of smoke detectors, according to the following schedule:

when the smoke level exceeds the alarm threshold, the panel does not signal anything at first;

- after 60 seconds if the smoke level is still above the threshold, the system goes into alarm condition, otherwise there are no signals;

- within 30 minutes, a new alarm of the same detector or activation of another sensor in the same zone causes the alarm of fire panel.

Cursor Keys No function is related to **Up** and **Down** keys.

Use the **Right** and **Left** keys to select: On-OFF.

ESC key Use the **ESC** key to delete the operation and to step back to previous page.

ENTER key Use the **ENTER** key to accept the selection and activate the programming page.

■ **Delay to Alarm**

For each zone, it is possible to program the activation of a common delay to alarm delay (9 minutes.). The procedure is the same as the previous parameters and also the functionality of the Cursors, Esc and Enter key is the same (see figure 44d).

■ **DLY ALARM TIME (min)**

If **ON** is selected for the option **Delay to Alarm** it will be possible to enter the zone relevant delay to alarm time. The possible value ranges from 0 (no delay) to 9 minutes. The value may be incremented or decremented in steps of 1 minute using the UP or DOWN keys.

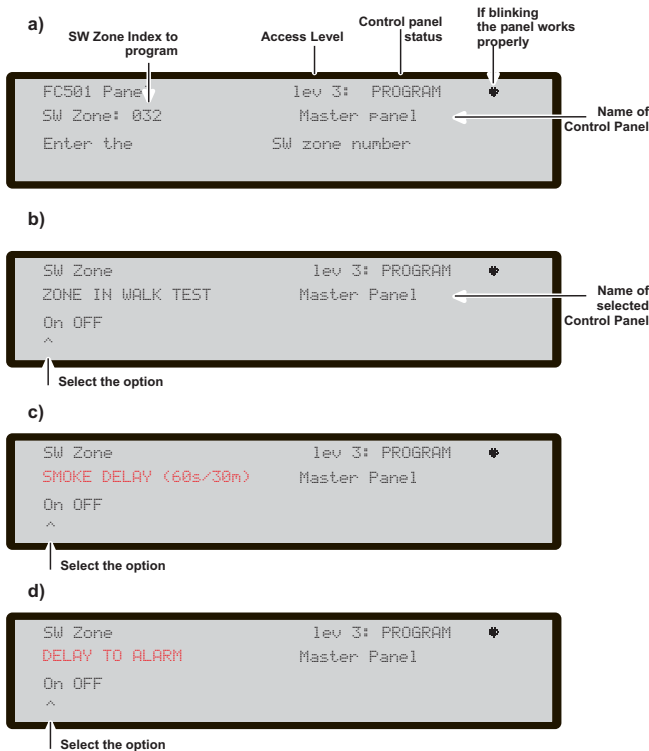

Figure 44 Page of programming option delay Detector alarm verification.

4 KEY- OUTPUT

The Outputs option, KEY 4 in the PROGRAMMING menu, activates the panel on the board output programming screen. It is used to select the type of panel on the board output, followed by the programming procedure for that output.

■ Choose Output

In this phase:

Alphanumeric keypad The Alphanumeric keypad is used to enter the number of SC output.

Cursor Keys The UP Key: shows the next output category (SC-OC).
The Down Key shows the previous output category.

Right and Left keys: no functions is related to these keys.

ESC Key Use ESC key to cancel the operation and to step back to previous page.

ENTER Key Use the ENTER key to accept the selection and activate the output selection and activate the loop device programming page if the output exists, otherwise a warning page is displayed for 5 seconds. "WRONG VALUE! enter the parameter again"
After 5 seconds the User Interface moves back to the page for selecting the outputs.

Once the Output has been programmed (type and identification number) and the ENTER key is pressed to accept the selection, enter the label for that output.

■ SET AS SC1

When set as **yes** the relevant output will behave as the SC1 (Sounder Circuit 1). This allows redundant output circuits to drive site sounders (by default set to no).

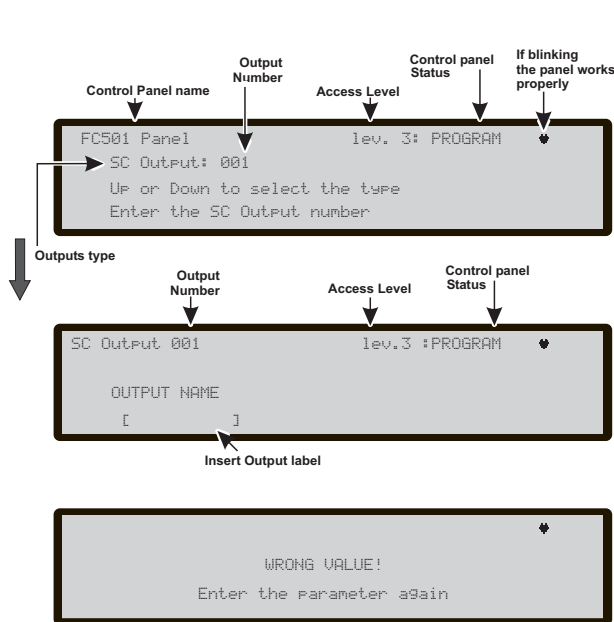

Figure 45 Pages for programming "SC active on disablements" option.

Setting the option to **yes** will end the programming sequence for that output.

The panel on board Open Collector outputs (OC1, OC2) may not be programmed to **ACT AS SC1**

■ PANEL ALARM TRIGGER?

When this option is set to **yes** (default), the relevant output becomes active on the panel alarm condition, otherwise a more specific trigger condition may be defined for that output.

■ DISABLEMENT TRIGGER?

This option activates the relevant output if any system part is disabled (by default set to **no**).

This parameter is made available only if the parameter **PANEL ALARM TRIGGER?**, for the same output is set to **NO**.

Setting the parameter to **YES** will end the programming sequence for that output.

Outputs which have this option programmed, will not be silenceable.

This feature is also available for Panel FIRE relay and FC410RIM, FC410SIO, FC410MIO, FC410QMO, FC410QRM, FC410QIO loop modules.

Further parameters which can be programmed via the panel's User Interface include:

- OUTPUT NAME
- TRIGGER ZONE 1
- TRIGGER ZONE 2
- TRIGGER EVENT
- SILENCEABLE
- MONOSTABLE

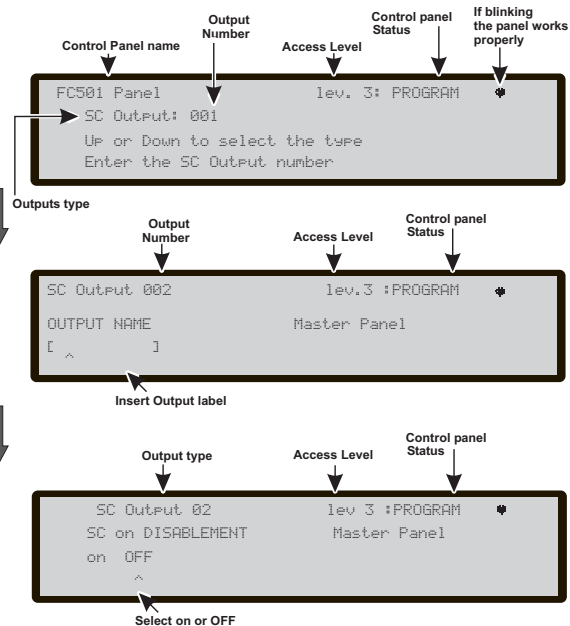

Figure 46 Pages of Selecting and programming SC active on disablement.

OUTPUT LABEL - enter or modify the relevant output label using alphanumeric entry mode, 20 characters maximum.

TRIGGER ZONE 1 - select the first zone on which events, defined later, the output will become active. The entry "0000" means "No Zone". Numeric entry mode, range from 0 - 32.

TRIGGER ZONE 2 - select the second zone on which events, defined later, the output will become active. The entry "0000" means "No Zone". Numeric entry mode, range from 0 to 32.

TRIGGER EVENT - define, for both trigger zones, the event types valid to activate the relevant output. The event types are coded as follows:

CODE	EVENT TYPE
ala	Alarm
dly	Delay to Alarm
war	Warning
fau	Fault
tst	Test
dk	Double Knock

You can select more than one TRIGGER EVENT (multiple selection mode)

The selected events are valid for all trigger zones.

When zones trigger condition act in "OR" mode, it is sufficient that the trigger condition of a single zone is matched to activate the output.

SILENCEABLE - select if the output stays active until the **SILENCE /RESOUND SOUNDERS** button is pressed (on option set) or stay active until the **RESET** button is pressed (off option set).

*In the case of "silenceable outputs", once silenced, it may be reactivated by pressing the **SILENCE/RESOUND SOUNDERS** button again.*

MONOSTABLE - allows the relevant output to automatically deactivate when the **MONOST. OUTPUT TIME** elapses. Set this to **ON** to enable this feature.

*The **MONOST.OUTPUT TIME** is set in the **SYSTEM** section of the **PROGRAM** menu and its value is valid for all outputs.*

5 Key- Network

The Network option of Programming menu activates the procedure to configure the modules FC500MFI.

When all the Control panels and the FC500MFI modules are connected in the Network,

1- use the **5 Key** to select **Network**, from Programming page in the User interface

2- the display in Figure 47 will be shown.

3- moving with the arrow keys to select the FC500MFI module to be configured ← or → (the symbol ^ under the name show the selected module), enable a FC500MFI module by the arrow ↑ or disable it by the arrow ↓:

The module name will appear in uppercase if enabled. Press the Enter key to confirm.

In the ANALYZE status (L1 level): to display the related status is used an acronym. The acronyms are:

" **OK!**", The net. device is sensed as connected and working;

" **ko!**", The net. device is sensed as not connected

" **FAU**", The net. device is faulty

" **DIS**", The net. device is disabled

" **--** ", The net. device is not configured in the network

" **OLD**", The net. device has an obsolete FW version.

For an explanation of the features and programming (addresses), see the dedicated manual of the FC500MFI module.

In this phase:

Alphanumeric keypad No function is related to the Alphanumeric keypad.

Cursor Keys The **Up** key enables the selected module (e.g. ON1-uppercase).

The **Down** key disables the selected module (e.g. on1-lowercase).

Use the **Right** key to select the module.

Use the **Left** key to select the module.

ESC Key Use **ESC** key to abort the programming procedure.

ENTER key Use the **ENTER** key to confirm the programming procedure and to leave the page.

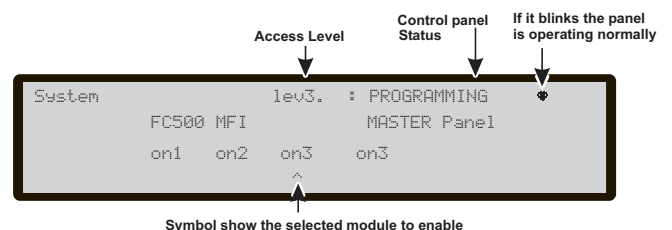

Figure 47 Display to enable the FC500MFI module.

6 KEY - MAP DEVICE

This option activates the "On Demand device mapping" feature to modify the devices addressing scheme in a working system. In a system where the addressing scheme is well known because all devices are singularly addressed via Service Tool or via the "device mapping" feature embedded in the loop enroll process (1 KEY). This means that this new feature is not intended to acquire new devices on the loops (for this purpose the Enroll feature have to be used).

In contrast to the "device mapping" feature embedded in the loop enroll process, the "On Demand" version will not automatically modify: devices labels and assigned zone.

All the devices, comprised also the "unique" types will put in the "activated list". The "only output" type devices are treated as in the standard device mapping procedure (they will be singularly activated when selected in the list).

In this phase:

Alphanumeric keypad The Alphanumeric keypad is used to enter the new address value: 0-9;

Cursor Keys the UP key, Short press: to scroll to the previous event in the list, Long press: to start the automatic scroll of the previous event in the list.

the Down key, Short press: to scroll to the next event in the list, Long press: to start the automatic scroll of the next event in the list.

The RIGHT key: to program the selected device.

The LEFT to continue the mapping procedure.

ESC key The ESC key: to end the mapping procedure and exit.

ENTER key the ENTER key: to confirm the entered address value.

To stop the automatic scroll, short press of the UP or Down key.

```

Device Mapping
Evt   Time  Type   add      done    000/002
001> 00: 19.50 P    L2:001< enter the address
002  00: 19.50 PH   L1:
    
```

Figure 48 Display "on demand device mapping".

7 KEY -USB

The option **USB** in the **PROGRAMMING** menu activates the **USB** programming page. 7 Key is used to select USB programming page, Figure 50 shows:

- 0) Extra
- 1) Load Audio
- 2) Save Audio
- 3) Load programming
- 4) Save programming
- 5) FW Upgrade
- 6) Save LOG.

In this phase:

Alphanumeric keypad Allows the selection of USB activities.

0) While the panel is running, it will be possible to load the two languages present in the USB key flash memory (previously downloaded from the CD supplied with the panel or from the FireClass site), see the diagram of operation in figure 46.

1) To load, from USB pendrive to panel, the AUDIO file containing the voice messages.

2) To save, from the panel to USB pendrive, the current AUDIO messages.

3) To load, from USB pendrive to panel, the programming data (*).

4) To save, from panel to USB pendrive, the current panel programming data.

5) To upgrade the panel Firmware from USB pendrive (**)(***).

6) To save the current LOG data in the panel from panel to USB pendrive.

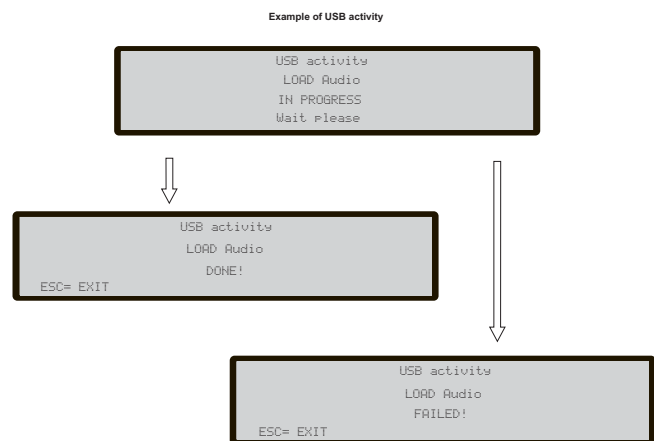

Figure 49 Example USB activities.

Control panel Status

Access Level

If blinking the panel works properly

```

FC501 Panel          lev.3 : PROGRAM
USB activities       0=Extra
1=Load Audio         2=Save audio   3=Load program
4=Save program       5=FW Upgrade   6=Save LOG
    
```

Activities

Figure 50 Page of USB activities.

Cursor Keys No function is related to **UP**, **Down**, **Right** and **Left** Keys.

ESC Key The **ESC** key is used to exit from the USB activity result page.

ENTER Key No function is related to the **ENTER** Key.

☞ (*) The loaded data will overwrite the current data in the panel.

☞ (**) The file containing the expected FW version to upgrade the panel has to be present in the F_fw directory in the pendrive.

☞ (***) To do the firmware upgrade of the FC500 Repeater and the MFI module is not possible using the USB pendrive.

In reference to the point 0) "EXTRA", at the first panel power-up and/or at the end of the FW upgrade process of the control panel, only a language can be loaded overwriting the second languages previously present (the first will be the English). The available language will be contained in a file of a dedicated folder on a USB stick connected to the control panel **before first Power up**.

This loaded language will be the language of the control panel. If the USB stick is not present at the first panel power-up, the system will propose the default language: Italian and English (see figures 51, 52).

In the case of FW UPGRADE of the control panel, at the end of the FW upgrade process, the panel will start the procedure "Language strings download via USB key at the first panel power-up", (see figure 52) in order to load the correct version of the required language.

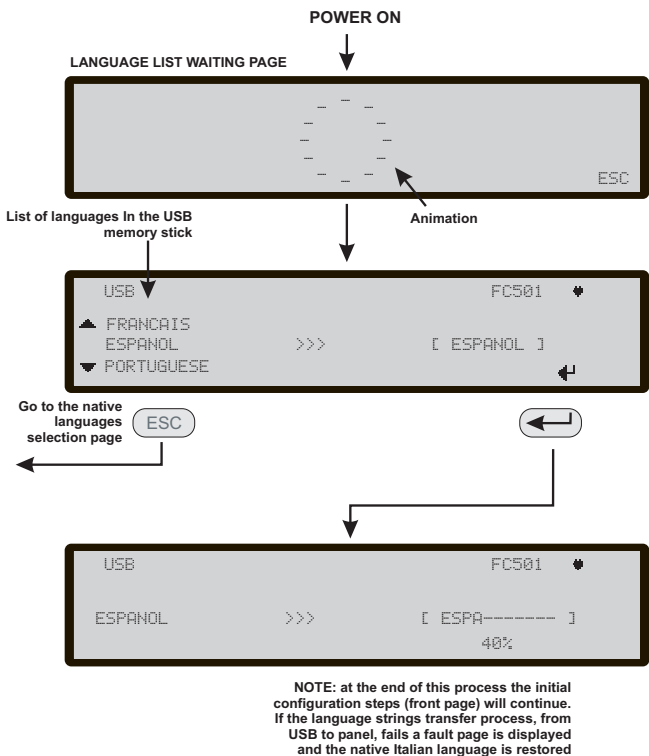

Figure 51 This figure displays the LCD page sequence required by feature: "Language strings download via USB key at the first panel power-up" (USB memory stick inserted and correct language file present).

8 KEY -SYSTEM

The option **SYSTEM** in the programming menu activates the system language selection page (Display language: see figure 51).

☞ Other languages can be loaded from software

After selecting the language, it is possible to program:

- PANEL ID
- PANEL TYPE (FC501-L/FC501-H)
- BATTERY TYPE (7Ah/12Ah/38Ah)
- DAY/NIGHT MODE or AUTO
- DELAY TO ALARM TIME.
- COPY ON ZONE?
- MONST. OUTPUT TIME
- ENABLE SCREEN SAVER
- 2 Wire Loops

Alphanumeric keypad No function is related to the Alphanumeric keypad.

Cursor Keys No function is related to **UP** and **Down** Keys.

Use the **Right** key to select the next option.

Use the **Left** key to select the previous option.

ESC Key Use **ESC** key to cancel the operation and to step back to MAIN page.

ENTER Key **ENTER** Key accepts the selection. In sequence:

■ Panel ID

Enter up to 4 digits to identify the configuration file system, so it is possible to distinguish it from other configuration files (for example on a USB stick, it is possible to load multiple systems without any configuration files overlap). In sequence:

- PANEL TYPE (FC501-L/FC501-H)
- BATTERY TYPE (7Ah/12Ah/38Ah)

■ Day / Night / Auto

The display for programming Day/Night/Auto mode will be shown. If Automatic mode is chosen, it is necessary to set the transition time from one mode to another.

☞ See the LED Day/Night mode LED change status.

In sequence:

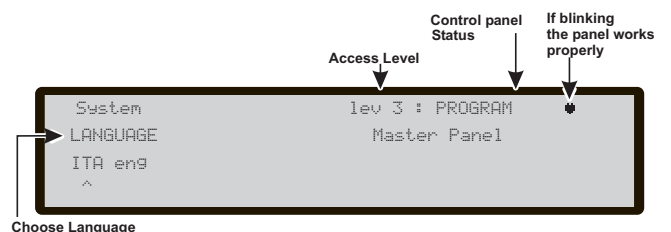

Figure 52 Page to select the language of the system.

■ **Delay to alarm time**

Enter the Delay to Alarm time in minutes (max 9).
The amount of Delay to Alarm Time+Investigation Time should not exceed 10 minutes.

■ **Copy on Zone?**

Moving on the **YES** option using the Cursor keys it is possible to copy the same Delay to Alarm time in all the zones.

■ **MONST. OUTPUT TIME**

Enter the period of time that the outputs, with the **mono-stable** option set, stay active once triggered. Value ranges from 1 minute to 30 minutes (default value is 3 minutes). It is valid for the entire system.

■ **ENABLE SCREEN SAVER**

When set as **YES**, the customizable front page is displayed, otherwise it is permanently removed.

■ **2 Wire Loops**

Each loop may be individually set to work in **2 wires** mode (multiple selection). When the **2 wires** option is selected, it is possible to connect devices on both the left and right sides of the the loops (2 spurs). This allows for the connection of up to 6 spurs to the panel, mimicing a 6 zones conventional panel.

Notes:

1. In all descriptions of the events, the devices are indicated as belonging to a loop. In the case of open loops, it is not possible to distinguish between the left and right side. Loop concept, therefore, will not be meaningful by definition, and localization will be performed via zones as in the case of conventional panels.
2. If devices are addressed by the Service Tool, there are two options to set them in 6 zones which correspond to the 6 spurs:
 - a) Connect addresses from 1-16 to the left side of loop 1, from 17-32 to the right side of loop 1, and so on. Then perform the enroll procedure and choose "By address" option for zone assignment (devices on the left side of loop 1 will be assigned to zone 1, those on the right side of loop 1 to zone 2, and so on.
 - b) Assign the correct zone to each device, via PC console or control panel LCD.
3. If devices are not addressed, a mapping procedure is performed to locate each device and assign the proper zone to it.

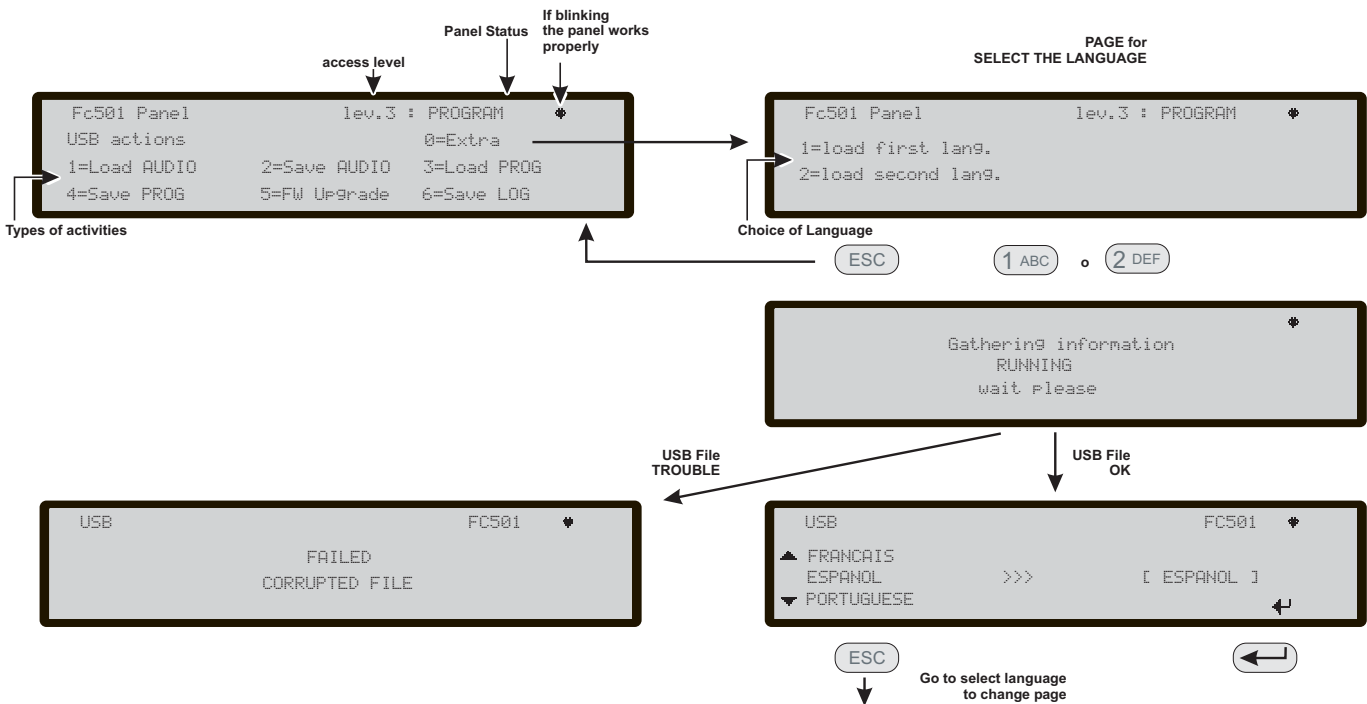

Figure 53 The scheme in the figure displays the LCD pages sequence required by this feature: "Language strings download during panel run time".

9 KEY- Restore Default

The Restore Default option from the PROGRAMMING menu will allow you to restore default setting.

Use the **9 Key** to select **Restore Default** (see Figure 54) .

Alphanumeric keypad No function is related to Alphanumeric keypad.

Cursor Keys No function is related to **UP, Down, Right** and **Left** Keys.

ESC Key The **ESC** Key cancels the procedure and returns to the previous page;

ENTER key The **ENTER** Key starts the default settings restore procedure.

 *If the motherboard of the Panel is connected with a FC500IP module, the procedure to Restore factory Default (key 9) will have no effect on the FC500IP module. To restore the FC500IP module to factory default use the procedure of the FireClass Console software.*

FC500REP Repeater Address

After the FC501 control panel has been connected, at the first start-up the FC500REP will verify the presence of the address and its conformity. If the address is correct, the Repeater will start to work; if the address is not correct the display will ask to insert a new address. The display on Figure 55 will be shown.

Alphanumeric keypad Use the alphanumeric keypad to insert the address of 1 digit.

Cursor Keys No function is related to **UP, Down, Right** and **Left** Keys;

ESC Key Use **ESC** key to cancel the operation and to step back to previous page.

ENTER Key Use the **ENTER** Key to confirm the address.

 *If for any reason the address of a repeater is changed by mistake, the system will show the message in the Figure 55, in this case the address of the repeater can be changed using the **ESC** key.*



Figure 54 Restore default page.

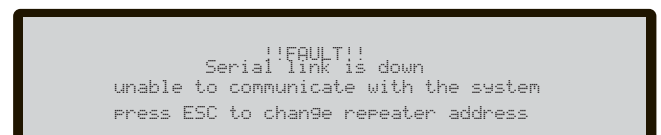

Figure 55 Display "the repeater link is down".

Accessing the Modify Menu

To access the **MODIFY** menu from the the MAIN page, you will be asked to enter the Installer 1 (default is 00000) or Installer 2 (default is 99999) password. Each entered digit will be hidden with the *symbol.

The Installer 1 and Installer 2 can access all the options described in the User Manual. Read the User Manual for more information.

Both Installer 1 and Installer 2 can access option 9 - Sounders. Only the Installer 1 can access option 7 - Password.

Accessing the Disable Menu

To access the **DISABLE** menu from the MAIN page, you will be asked to enter the Installer (default is 00000) or Installer 2 (default is 99999) password. Each entered digit will be hidden with the * symbol.

The Installer 1 and Installer 2 can access all the options described in the User Manual. Read the User Manual for more information.

Both Installer 1 and Installer 2 can access option 9 - Sounders. Only the Installer 1 can access option 7 - Password.

7 Key - Password (Disable)

This option is enabled only if you enter in the Control Panel using a Master Installer PIN (Default 00000). The Key 7 is used to select the Disable **Password** option, after the option has been selected the corresponding password will be disabled/enabled (Figure 56).

■ Select the Password

In this phase:

Alphanumeric keypad Use the Alphanumeric keypad to select the identification number of Password.

Cursor Keys Use the **UP** Key to show the next type of password;

Use the **Down** Key to show the previous type of password. The types of password are User Password and Installer Password.

No function is related to the Right and Left Keys.

ESC Key Use the **ESC** key to cancel the operation and to return to previous page.

ENTER Key Use the **ENTER** Key to confirm.

■ Disable Password

In this phase, the display shows the current status of the selected Password (User or Installer). The possible actions are: ENABLE or DISABLE.

Alphanumeric keypad No function is related to Alphanumeric keypad.

Cursor Keys No function is related to the **UP**, **Down**, **Right** and **Left** Keys.

ESC Key Use the **ESC** key to cancel the operation and to return to previous page.

ENTER Key Use the **ENTER** Key to confirm. The User Interface moves to the MAIN page followed by a panel reset.

9 Key- Sounders

This option is visible only if you enter the Control Panel using the Installer 1 (default 00000) or Installer 2 (default 99999) password.

This option allows you to enable or disable all the sounders on board or on the loop: SC1, SC2, loop sounder outputs (SAM, SAB, SNM, AV bases Symphoni sounders).

Press 1 to enable all sounders: the event "ALL SOUNDERS ENABLED" is memorized into the log.

Press 2 to disable all sounders: the event "ALL SOUNDERS DISABLED" is memorized into the log.

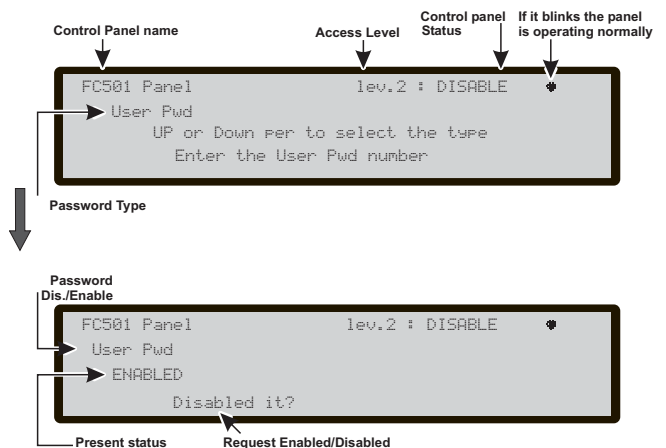

Figure 56 Display Enabled/Disabled Password.

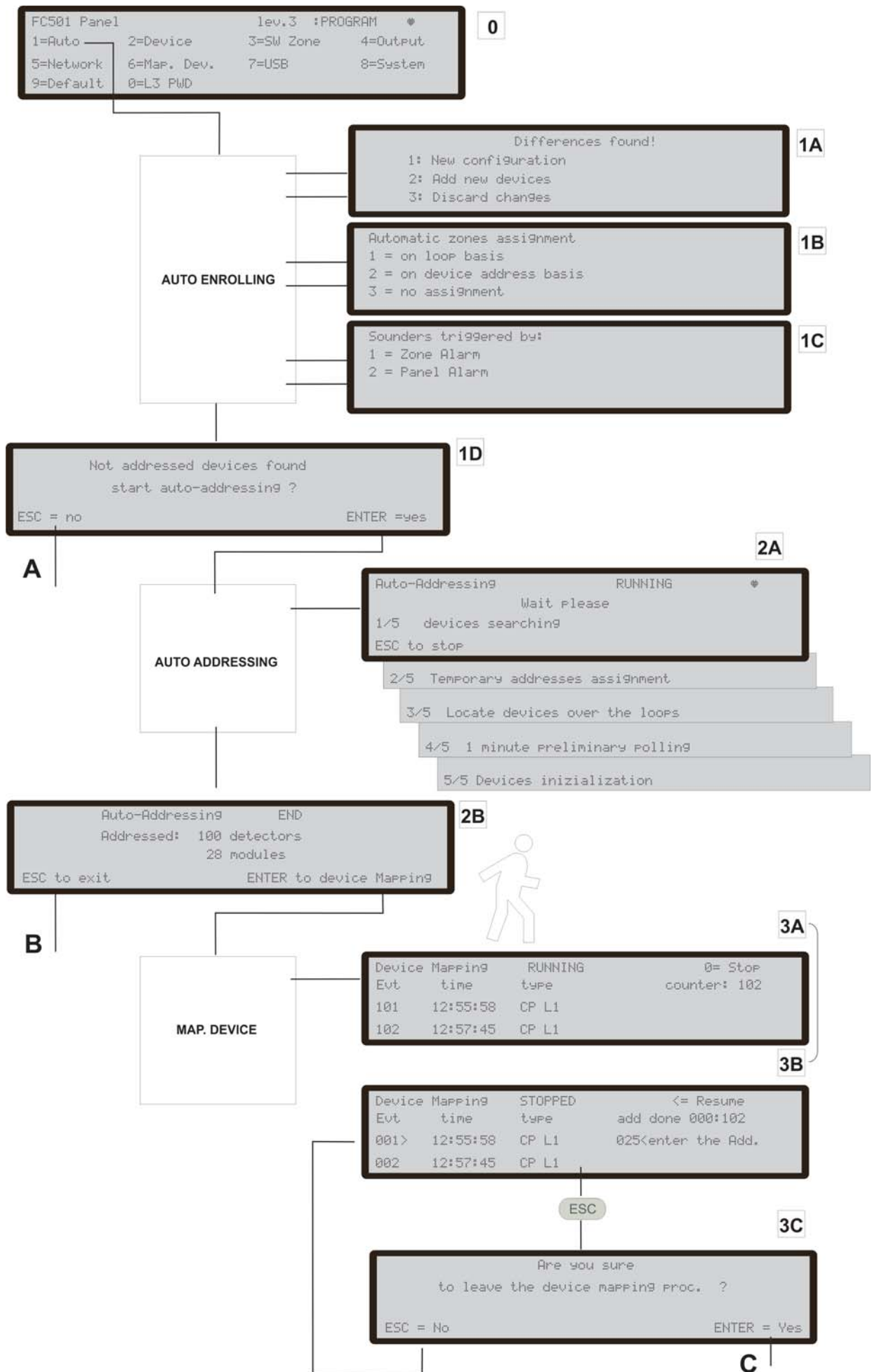



Figure 55 Programming option "AUTO".

QUICK START-UP PROCEDURE

This procedure allows the quick start-up of the FC501 fire detection system.

When the loops are wired, electrically verified and all the devices have been installed in to the loop, it is possible to connect the loops terminals to the panel.

 *Before powering-on the Fire control panel, ensure that the Earth Line has been connected.*

PROCEDURE

1. Turning on the panel will start a FW procedure to verify/program information for the User Interface and for the panel, which ensures that functions are programmed and are consistent. This information includes:

- Selected language
- Panel Identification number
- The panel Type (FC501-L/FC501-H)
- Installed batteries capacity (7Ah/12Ah/38Ah)

2. When the previous data has been verified/programmed, insert the date and time. This step is important as it guarantees the Log file consistency.

At this point the panel will start the first system initialization verifying the loops integrity.

 *NOTE: The panel in this phase is configured to manage closed loops (4 wires loop). If it is connected to a spur (2 wires loop), it will generate broken loop faults.*

At the end of this first initialization phase, the User Interface will be displayed at the main page with the capability to accept to the command and control functions.

3. Select the function Program pressing the key 1.
4. Insert the installer password (default=00000) every digit will be masked by * symbol.
5. Choose the option by pressing the key 1.

The panel will start the enrolling procedure.

This procedure is divided into three main phases:

- 1 Auto-learning
- 2 Auto- addressing
- 3 Device Mapping

It is possible to stop the "AUTO" option at the end of each phase; the results are different.

1 AUTO-LEARNING

In the first phase the panel looks for all the devices on the loop already addressed (with the service tool).

During this phase, the panel will ask what pattern of automatic assignment of zones shall be applied to found devices (see Figure 55,1B) and the panel will ask the sounder's triggering scheme (see Figure 55, 1A).

In the case of panel already configured, it indicates any differences and asks how to proceed (see Figure 55, 1A), in which case the scheme of Automatic assignment of the zones will be applied only to new devices found.

If you stop the AUTO option at the end of this first phase, Figure 55, A will happen :

- The control panel will take over all devices with an address between 1 and 128.
- The programming device at their default configuration.
- Automatic assignment of labels.
- Automatic assignment of the zones according to the scheme chosen during that phase.
- The output channels of the modules are enabled to activate on fire alarm of the assigned zone. The sounders, sounders and beacons, sounder bases, AV (Audio Visual) bases and the FC430SNM modules will activate according to the trigger scheme chosen in in this phase. If it was chosen to assign all devices to system (no zone auto assignment), all of the output modules, sounders and beacons will be triggered by the Panel alarm condition.
- The faults "NOT PROGRAMMING DEVICE" and "wrong addresses" will be generated in the case of not addressed devices or with address greater than 128, respectively.

 *If the enrolling result differs from the previously stored loop configuration a warning message will be displayed and it is possible to reject the present enrolling result, maintaining the previous configuration, or accept them. See Fig 55 1A.*

2. AUTO-ADDRESSING

The second phase starts, if during Auto-learning phase, not addressed devices have been identified or have an address greater than 128. During this phase all the not addressed devices will be detected. The panel assigns them a temporary address and configure them at default (see Figure 55, 2A).

If you stop the AUTO option at the end of this second phase, Figure 55, B) will happen:

- The auto assignment of the address to the not addressed devices
- The control panel will take over all devices
- The programming devices to their default configuration.
- Automatic assignment of labels.
- Automatic assignment of zones based on a loop of belonging.
- The output channels of the modules, sounders and beacons will be set to active on the alarm of the assigned zone.

3. DEVICE MAPPING

The third and last phase is activated on demand at the end of the Auto-addressing phase.

In this phase, it is possible to:

- Locate the positioning in the system of all the devices through their activation (in the case of output modules only, sounders or beacons, they will be suitably activated by the panel (see Figure 55, 3A).
- Carry out a preliminary test of the system.
- Program the most important parameters of each located device.
- Automatically assign labels to all devices.
- Assign automatically the zones based on assigned address to each device.
- Automatically configure the output channels of the modules, sounders and beacons to activate on the alarm of the assigned zone.

LOOP	PANEL	MESSAGE			
		Differences found!	Automatic zones assignment	Not addressed devices found start autoaddressing ?	
1	All devices not addressed	DEFAULT		*	
2	Some devices addressed + Some devices not addressed	DEFAULT		(Applicable only to the already addressed devices) *	
3	All devices addressed	DEFAULT		*	
4	Fully addressed Same configuration	CONFIGURED			
5	Fully addressed Different configuration	CONFIGURED	*	New configuration	(Applicable only to all already addressed devices) *
			*	Add devices	(Applicable only to new already addressed devices) *
6	Same configuration + Not addressed devices	CONFIGURED		*	
7	Different configuration (*) + Not addressed devices	CONFIGURED	*	New configuration	(Applicable only to all already addressed devices) *
			*	Add devices	(Applicable only to the new already addressed devices) *

Table 10 This table shows the type of messages, and relevant action required during the enroll process in function of the loop and panel configuration. Note (*) indicates that the message is displayed and relevant action is executed.

The third phase represents a powerful and flexible tool that allows to "draw" the plant being in front of the panel and without the use of a PC and its SW configuration.

A series of controls have been designed to prevent the generation of incorrect or not manageable conditions.

To locate each device, the address to be assigned:

- does not belong to an older generation device (FC400 series).
- is in the range from 1 to 128.
- belongs to a new generation device and that device is present in the list of devices to locate.
- is not among those assigned automatically.

In each case at the end of the device Mapping phase (see Figure 55,C) a check is performed to detect the presence of "doubles addresses". In this case the involved addresses are indicated and it is not possible to end the procedure until the error condition is removed.

 *The procedure for the devices mapping can also be launched outside the AUTO function, by activating the programming function called "localization. (Key 6, on the PROGRAM status) that allows to activate the procedure for devices mapping on demand, on a system already configured and without the need to proceed to their activation. It is meant to correct errors or change the system "on the run" and use all the features and capabilities described above.*

System default

■ Zone assignment

To mimic a conventional panel, the acquired device over the loops will be automatically assigned to a predefined zone. Two different scenarios are possible:

Exit at the end of the Auto Addressing phase without executing the Device Mapping process, in this case:

- all the devices located on loop #1 will be assigned to zone #1
- all the devices located on loop #2 will be assigned to zone #2
- all the devices located on loop #3 will be assigned to zone #3.

At the end of the Device Mapping process.

The device address to zone assignment scheme is the follow:

- From address 01 to address 16 assigned to zone #1
- From address 17 to address 32 assigned to zone #2
- From address 33 to address 48 assigned to zone #3
- From address 49 to address 64 assigned to zone #4
- From address 65 to address 80 assigned to zone #5
- From address 81 to address 96 assigned to zone #6
- From address 97 to address 112 assigned to zone #7
- From address 113 to address 128 assigned to zone #8

If an address is not manually assigned to a device (either via FC490ST or during the device mapping phase) no zone will be assigned to it.

The previous zone assignment schemes are applied also to the first "trigger zone" in the case of output only devices (sounder, beacon, SNM module,...) or output channel of Input/output devices.

 *Note that in the case of non zone assigned, the output channel trigger event is the panel alarm.*

■ System default parameters

System default parameters

Temperature detector	default values
Label	See note (**)
Enablement	Enabled
Led blink	On
Assigned zone	(see: "Zone assignment)
Base type	Normal
Use zone setting	Yes
Day operating mode	A2S
Night operating mode	A2S

TSM module	default values	General options	default values
Label	See note (**)	Investigation delay	300s
Enablement	Enabled	Main fault delay	1m
Led blink	On	Delay to alarm	60s
External power	On	Silence duration	60s
Input function	Door monitoring	Reset	2s
Loop monitoring	Off	Loop 1 wires	4 wires
Door monitoring event	Fault	Loop 2 wires	4 wires
Monitoring time	30s	Loop 3 wires	4 wires
		Day/Night mode	Day mode
Input Channel		SC1 disablement	Enabled
		PSTN communicator enablement	Not operative
Enablement	Enabled	IP communicator enablement	Not present
Channel Label	See note (**)	NETWORK enablement	Disabled
Assigned zone	Address related	Delay from alarm #1	0s
(see: "Zone assignment")		Delay from alarm #2	0s
Operating mode	Style C, NO	Delay from alarm #3	0s
		Delay from alarm #4	0s
Output channel		Delay from alarm #5	0s
Enablement	Yes	PSTN communicator	default values
Channel label	See note (**)	Tone check	On
Trigger zone #1	Address related	Start playing after	Selection
(see: "Zone assignment")		Call attempts	3
Trigger zone #2	None	Iteration	3
Trigger point #1	None	Call all telemonitoring numbers	No
Trigger point #2	None	Call all voice message numbers	No
Trigger point #3	None	Telephone number label	TEL. NUMBER xx(****)
Silenceable	Yes	All Telephone numbers behavior	None
Trigger on event	Zone Alarm	Trigger events	Panel alarm, Panel Fault
Delay from alarm	Off	Message #1 to #7	Pre recorded
Zones	default values		
Label	Zone AAA(*)		
Enablement	Enabled		
Walk test	Off		
Detector warning	Off		
Delay to alarm	Off		
Drift compensation	Off		
Double knock	Off		
Smoke verification	Off		
Delay to alarm duration	0s		
On board programmable outputs	default values		
Enablement	Yes		
Channel label	tttt y(****)	xxx = module acronym	
Trigger zone #1	none	yyy= module address	
Trigger zone #2	None		
Trigger zone #3	None	For example "DDM098: Ingresso A" is the default label for	
Trigger zone #4	None	the input #1 of the FC410DDM module at address 98.	
Trigger point #1	None		
Trigger point #2	None	(****) tttt represent the on board output type (4 chars),	
		SC outputs -> tttt="SC "	
Trigger point #3	None		
Silenceable	Yes	Programmabel outputs -> tttt="OC "	
Active on disablement (where applicable)	Off		
Trigger on event	none	y = output number	
Delay from alarm	Off	(*****) xx represent the telephone number ID (2 digits),	

The following is a list of accessories for FC501 control panel, with a description of the main features. For further information about these accessories, please refer to the instructions supplied with the accessories themselves or download them from the website: <http://www.fireclass.net>.

FC500IP - IP Module

The FC500IP is an IP Module which is used to connect the FC501 fire panel to a LAN.

The IP Module may be connected to a LAN using a private IP address or a DHCP address.

The same procedures may be performed using the FireClass console application, either through the serial port or the network. With a public IP address, it is also possible to manage and monitor the control panel from anywhere in the world, as long as you have access to the Internet.

4B - Universal Base

The 4B Universal base is for use with the FC460/FC400/600 series of detectors.

The base may be fixed directly to:

- British (fixing centres 50mm) or European (fixing centres 70mm) conduit box.
- 4B EM Euro Mounting Box.
- the suspended ceiling, through the CTA adapter.
- directly to the ceiling.

FC460H or FC400H-Addressable Heat Detector

The detector is intended to plug into the following:

- 4B 4" Universal Base
- 4B-I 4" Isolator Base
- FC430SB Low Power Sounder Base
- FC430LPSB Loop Powered Addressable Sounder Base.
- FC430LPASB Loop Powered Addressable Sounder/Beacon Base.

Software within the controller is used to interpret the returned heat values to raise an alarm or other appropriate responses according to the type of detector configured in Fire Class Console.

The mode of detector may be:

- EN54-5 A1R, rate-of-rise normal ambient
- EN54-5 A2S, fixed 60°C
- EN54-5 CR, rate-of-rise high ambient.

FC460P or FC400P - Addressable Optical Smoke

The FC460P/FC400P optical smoke detector forms part of the FC460/FC400 Series Addressable Fire detectors.

- 4BI 4" Isolator Base
- 4B 4" Universal Base
- FC430SB Low Power Sounder Base
- FC430LPSB Loop Powered Addressable Sounder Base.
- FC430LPASB Loop Powered Addressable Sounder/Beacon Base.

Software within the controller is used to interpret the returned optical and heat values to raise alarm or other appropriate response according to the type of detector configured in Fire Class Console.

FC460PH or FC400PH - Addressable Optical Smoke & Heat Detector

The detector is intended to plug into one of the following:

- 4B 4" Universal Base
- 4B-I 4" Isolator Base
- FC430SB Low Power Sounder Base
- FC430LPSB Loop Powered Addressable Sounder Base.
- FC430LPASB Loop Powered Addressable Sounder/Beacon Base.
- Software within the controller is used to interpret the returned optical and heat values to raise alarm or other appropriate response according to the type of detector configured in Fire Class Console. The mode of detector may be:

- Optical smoke only detector (sensitivity High, Normal or Low)
- Optical (sensitivity High, Normal or Low) and heat fixed temperature 60°C (A2S)
- Heat only rate-of-rise (A1R) detector (no sensitivity selection)
- Heat fixed temperature 60°C (A2S) (no sensitivity selection)
- Heat rate-of-rise (A1R) detector and optical smoke (sensitivity High, Normal or Low)
- HPO (Advanced) smoke detector (sensitivity High, Normal or Low)
- HPO Enhanced with heat fixed temperature 60°C (A2S)
- HPO Enhanced rate-of-rise (A1R).

FC460PC Addressable Optical Smoke & Heat Detector & CO

Detector of high performance, of smoke, temperature and CO. The use of the three elements of the sensor, in synergy, allows to determine with accuracy the presence of all types of fires and at the same time having an exceptional immunity to false alarms.

The functionalities of the FC460PC detector are: self-monitoring, self-testing, status indicator, remote LED and threshold compensation. The detector FC460PC is compatible with the existing bases.

FC410LI - Line Isolator Module

The FC410LI Line Isolator Module is designed to be used on the FC addressable controller loop circuits. It monitors the line condition and when detecting a short circuit will isolate the affected section while allowing the rest of the addressing circuit to function normally.

The purpose of the FC410LI Line Isolator Module is to ensure that, on a looped addressable system, no short circuit fault can disable more detection devices than would be lost on a conventional non-addressable fire circuit.

FC410MIM - Mini Input Module

➤ The FC410MIM Mini Input module is designed to monitor fire contacts, such as extinguishing system control, ventilation control, fire door control etc. The module provides one identifiable detection spur which is capable of monitoring multiple normally open contacts or a single normally closed contact. The FC410MIM may be mounted in any electrical enclosure with sufficient depth to accommodate FC410MIM and the contacts monitored by the IN+ and IN- terminals, ie, no field wiring. The remote LED (if required, not supplied) must be located within the same electrical enclosure.

FC410MIO - Small Addressable Multi I/O Module

The FC410MIO Multi I/O Module has three class B inputs and two outputs from latching relays. The class B inputs can monitor fire contacts such as extinguishing system control, ventilation control, fire door control etc. The two relays outputs are dry form C that provide volt-free relay changeover contacts. A maximum of two HVR800 High Voltage Relay Modules can be individually driven and controlled by an FC410MIO if all HVR800s are powered by 24V dc or 24V ac. In this application, the HVR800s are controlled by the two latching relays on the FC410MIO. A maximum of four HVR800 High Voltage Relay Modules can be individually driven and controlled by an FC410MIO if all HVR800s are powered by 120V ac or 240V ac. In this application, the HVR800s are controlled by the four control outputs (O1+/O1- to O4+/O4-) on the FC410MIO.

FC410SIO - Single Input/Output Module

The FC410SIO Single Input/Output Module is designed to provide a monitored open collector input and a volt free relay changeover output.

FC410SIO can switch up to 2 A @ 24 Vdc.

FC420CP - Addressable Break Glass Callpoint (indoor)

FC420CP Addressable Break Glass Callpoint is designed to monitor and signal the condition of a switch contact that is operated by activating the break glass element. The type of alarm generated by the callpoint is configured in FireClass Console. The FC420CP call point meets the requirements of EN54 Pt.11. The FC420CP is fitted to a standard surface mount plastic backbox, standard single gang metal plaster box (35 mm for flush mounting) or standard single gang metal plaster box (25 mm) with backbox.

FC421CP - Addressable Break Glass Callpoint (outdoor)

➤ FC421CP Weatherproof Addressable Break Glass Callpoint is designed to monitor and signal the condition of a switch contact that is operated by activating the break glass element. The type of alarm generated by the callpoint is configured in FireClass Console. The FC421CP callpoint meets the requirements of EN54 Pt.11. The FC421CP is fitted into a standard weatherproof break glass callpoint housing.

FC430SAB/SAM - Sounder Base Address Modules

The Sounder Base Address Modules (FC430SAM/FC430SAB) are designed to control a loop powered sounder base for use with the FCsystem, one variant (FC430SAB) has an integral beacon. They may also be used to drive a relay base. The units are used to supply the address decoding in place of a detector, thus providing a loop powered sounder when used in conjunction with an FC430SB. The modules are colour matched to the sounder bases. The FC430SAM/FC430SAB is locked into the base using the locking device integral to the sounder base.

FC430SB - Loop Low Power Sounder Base

The FC430SB Loop Low Power Sounder Base provides an additional sounder function on the FC addressable loop circuit. The FC430SB Loop Low Sounder Base requires an associated detector in order to operate, as it uses the address of the detector that is fitted to it. Removal of the detector or loss of power to the loop will cause the sounder to cease operating. A maximum of 30 Sounder Bases at full volume may be connected to the loop.

4B-I - Isolator Base

The FC460/FC400 Series Detectors, as supplied, use a common 4B-I Isolator Base assembly.

The base may be fixed directly to:

- British (fixing centres 50mm) or European (fixing centres 70mm) conduit box.
- FC450EMB Euro Mounting Box.
- Directly to the ceiling.

FC490ST - Loop Service Tool

The FC490ST Loop Service Tool is used to program the loop address into FC addressable devices. The FC490ST displays information and performs tests on devices. It has a 32 character backlit LCD alphanumeric display, arranged in 2 rows of 16 characters and four 'softkeys', F1, F2, F3 and F4. Power for the FC490ST is derived from 4 AA size nickel metal hydride rechargeable batteries. It may be run from an unregulated +12V dc input ie, car cigarette lighter connection or 110/230V ac mains adaptor, both of which will also recharge the batteries.

FC410BDM - Beam Detector Module

- The FC410BDM Beam Detector Interface Module is designed to interface FIRERAY 50 Beam Detectors to the FC Digital Addressable Loop (it must not be used with other types of beam detector). The FC410BDM monitors the Fire and Fault contacts and also monitors for open and short circuits on the connections between the interface and the beam detector. For remote siting of the FIRERAY 50 an optional BTM800 Terminal Module can be used with 4 core cable.

The FIRERAY 50 transmitter and receiver units are mounted in the same housing.

The FC410BDM Loop Powered Beam Detector Interface Module is contained on a double sided printed circuit board (PCB) which is fitted into a custom built fascia plate with a protective cover being fitted over the PCB, leaving only the connection terminals exposed. The fascia plate is then fitted onto a standard dual-gang back box with BESA fittings.

FC410CIM - Contact Input Module

- The FC410CIM FC Addressable Contact Input Module is designed to monitor fire contacts such as extinguishing system control, ventilation control, fire door control etc. The FC410CIM can be configured as:
 - Two spur circuits (Class B) monitoring multiple normally open contacts, with short circuit giving a fault output.
 - Two spur circuits (Class B) monitoring single normally closed contacts, with short circuit giving a fault output.
 - Two spur circuits (Class B) monitoring multiple normally open contacts, with short circuit giving an alarm.

FC410DIM - Detector Input Module

The Addressable FC410DIM provides the ability to connect and Interface one or two zones of 24V dc 2-wire conventional detectors (non-addressable) to the Fire Alarm Controller.

The FC410DIM monitors the status of detectors and wiring to detectors and signals detector and wiring status back to the Controller.

FC410RIM - Relay Interface Module

The FC410RIM Relay Interface Module provides one volt-free relay changeover contact on a latching relay. The relay is controlled by a command sent from the FC fire controller via the addressable loop. The relay state (activated, deactivated or stuck) is returned to the controller.

FC400CH - Addressable Carbon Monoxide + Heat Detector

- The FC400CH carbon monoxide plus heat detector forms part of the FC400 Series Addressable Fire detectors.
 - The detector is intended to plug into the following:
 - 5B 5" Universal Base.
 - FC450IB 5" Isolator Base.
 - FC430SB Low Power Sounder Base.
 - FC430LPSB Loop Powered Addressable Sounder Base.
 - FC430LPASB Loop Powered Addressable Sounder/Beacon Base.

The detector is designed to transmit, to a remote Fire Class controller, digital signals which represent status of the carbon monoxide and heat elements of the detector. Software within the controller is used to interpret the returned carbon monoxide and heat values to raise alarm or other appropriate response according to the type of detector configured in Fire Class Console.

801RIL - Remote LED Indicator

The 801RIL Remote Indicator is used where a detector LED is not visible ie, when the detector is mounted in a roof void, lift shaft etc. The 801RIL is mounted to a single gang electrical box and is supplied with 2 x M3.5 screws.

801HL - Remote LED Indicator

The 801HL Remote Indicator is used where a detector LED is not visible ie, when the detector is mounted in a roof void, lift shaft etc.

The 801HL provides a larger indicator for use in place of the 801RIL when longer distances are involved or in VdS influenced markets.

The 801HL can be mounted to any suitable flat surface and has fixing centres at 60 and 80mm.

HVR800-High Voltage Relay

➤ The HVR800 High Voltage Relay Interface is a non-addressable multi-voltage relay module (operating from 24V dc, 24V ac, 120V ac and 240V ac).

The encapsulated HVR800 provides a 10 amp volt-free contact that can be used to extend the contact ratings of FC410RIM Addressable Relay Module applications.

A maximum of four HVR800s can be individually driven and controlled by an FC410MIO Small Addressable Multi-Input/Output module if all HVR800s are powered by 120V ac or 240V ac. For ac operation, no external dc power supply unit is required to operate the relay.

When used to switch 24V dc, the HVR800 must be provided with an external 24V dc supply which should be switched through the clean relay contacts of an FC410MIO or FC410RIM.

DPK4/DPKI

➤ The DPK4/DPKI duct probe units have been developed to detect smoke in ventilation ducts. These duct probe units can be used in combination with a wide range of detectors and are suitable for addressable and conventional systems. The duct probes can operate across a wide range of air velocities from 1m/s to 20m/s. The Duct Probe units have a built-in FireClass Universal Base 5B. There is a range of aluminium probe tubes available for air ducts up to 1500 mm.

FIRERAY 50/100-Optical Beam Smoke Detector

The Detector comprises of a Transmitter and Receiver contained within one enclosure.

The Transmitter emits an infrared light beam that is reflected via a prism mounted directly opposite and with a clear line of sight. The reflected infrared light is detected by the Receiver and analysed.

The Detector has a maximum lateral detection defined by the local National Standard. As a guide a common lateral distance of 7.5m will be used in this guide. Use the latest beam detector standards EN54 part 12, VdS2095 or BS5839 part 1 for further guidance.

The optimal beam distance from the ceiling will be between 500mm and 600mm, again the Local National Standard will give guidance.

Range: Fireray 100 = 50-100 meter

Fireray 50 = 5-50 meter

Coverage area: Fireray100 = up to 1500 sqm.

Fireray 50 = up to 750 sqm.

FIRERAY 3000

The FIRERAY 3000 Optical Beam Smoke Detector is ideal for applications where the line of sight for the IR (infra-red) detection path is narrow and where the building structure uses reflective surfaces. The unit emits a narrow beam of infra-red (IR) light in order to monitor for smoke and is controlled using a compact low level controller. It allows for the installation of 2 detectors for each system controller. There is a 2-wire interface between controller and receiver. For each detector there are separate fire and fault relays. The FIRERAY 3000 has been designed so that it can be installed by one operator with its laser assisted alignment methods combined with easy to use alignment LED's offering visual feedback. Integrated laser alignment aid can be activated at the controller or at the receiver head.

➤ Range: 5-120 metres, configurable per set of Detectors

FIRERAY 5000

The FireRay 5000 motorised, auto-aligning infrared optical beam smoke detector can be installed with up to 4 detector heads per system. Once the detector heads are connected, using the *Easifit First Fix* system, an integral LASER, which is aligned along the optical path of the beam, can be activated. This allows the reflective prism to be sighted quickly. Once the LASER has been used to coarsely align the beam, the Auto-Optimise beam alignment system takes over and automatically steers the beam into the optimum position. The System Controller retains one set of Fire and Fault relays that is common to all detectors installed.

➤ Range: Each detector is configurable from 8m to 100m.

FC410LPSY and FC410LPAV loop powered sounders and sounder-beacons

➤ The FC410LP Series of Loop Powered Addressable Sounder/ Sounder-Beacons are designed to be driven from an FireClass control panel via the addressable loop. The FC410LP Series of sounders/sounder beacons consist:

FC410LPSYR: Sounder (indoor use) - red housing

FC410LPSYW: Sounder (indoor use) - white housing

FC410LPSY: Sounder IP65 (outdoor use) - red housing

FC410LPAVR: Sounder-Beacon (indoor use) - red housing

FC410LPAVW: Sounder-Beacon (indoor use) - white housing

FC410LPAV: Sounder-Beacon IP65 (outdoor use) - red housing

The sounder has two volume settings 'High' (103 dB ±3) or 'Low' (90 dB ±3).

The beacon has two flash rates 'Slow Flash' (1/2 Hz) or 'Fast Flash' (1 Hz).

The FC410LP devices are synchronised, but not synchronous with other FireClass sounders (FC410SNM) and beacons (FC430SAB).

The first flash of the beacon is synchronised with the start of the tone.

The FC410LP devices have a built in two port isolator.

FC410LPBS-R/W loop powered sounders and sounder-beacons (EN54-23)

The FC410LPBS Series of Loop Powered Addressable Sounder/ Sounder-Beacons are designed to be driven from a FC501 control panel via the addressable loop. The FC410LPBS Series of sounders/sounder beacons consist:

FC410LPBS-R: Sounder (indoor use) - red housing

FC410LPBS-W: Sounder (indoor use) - white housing

FC410LPAV: Sounder-Beacon IP65 (outdoor use) - red housing

The sounder has two volume settings 'High' (103 dB ±3) or 'Low' (90 dB ±3).

The beacon has two flash rates 'Slow Flash' (1/2 Hz) or 'Fast Flash' (1 Hz).

The FC410LPBS devices are synchronised, but not synchronous with other FireClass sounders and beacons of the FC400 series.

The first flash of the beacon is synchronised with the start of the tone.

The FC410LPBS devices have a built in two port isolator. The table in Table 11 demonstrates the connection between the managed devices in the current version and the the new EN54-23

FC430LPSB and FC430LPASB Loop Powered Addressable Sounder/Beacon Base

➤ The FC430LP Series of Loop Powered Addressable Sounder/Sounder- Beacons are designed to be driven from an FC501 control panel via the addressable loop. Tone, volume and flash rates are set in FireClass Console.

The sounder has four volume settings 'High' (90dB ±3), 'Mid High' (80 ±3dB), 'Mid Low' (70 ±3dB) or 'Low' (60dB ±3). The beacon has two flash rates 'Slow Flash' (1/2Hz) or 'Fast Flash' (1Hz). The FC430LP Series have a built-in line isolator.

FC430LPBSB Loop Powered Addressable Sounder/Beacon Base (EN54-23)

➤ The FC430LPBS Series of Loop Powered Addressable Sounder/Sounder- Beacons are designed to be driven from an FC501 control panel via the addressable loop. Tone, volume and flash rates are set in FireClass Console.

The sounder has four volume settings 'High' (90dB ±3), 'Mid High' (80 ±3dB), 'Mid Low' (70 ±3dB) or 'Low' (60dB ±3). The beacon has two flash rates 'Slow Flash' (1/2Hz) or 'Fast Flash' (1Hz).

The FC430LPBS Series have a built-in line isolator.

FireClass Product code (Current Dev.)	FireClass Device name (Current Dev.)	Description	FireClass Product code (EN54-23 Dev.)	FireClass Device name (EN54-23 Dev.)
516.800.758	FC430LPASB	Loop Powered Beacon Sounder Base	516.800.973	FC430LPBSB
516.800.763	FC410LPAVR	Loop Powered Beacon/Sounder (indoor use) red	516.800.970	FC410LPBS-R
516.800.764	FC410LPAVW	Loop Powered Beacon/Sounder (indoor use) white	516.800.971	FC410LPBS-W
516.800.766	FC410LPAV	Loop Powered Beacon/Sounder IP65 (outdoor use)	516.800.972	FC410LPBS

Table 11 Connection between the current version and the new EN 54-23.

☞ *It is possible to substitute old devices with correspondent new ones (EN54-23), keeping the same program data. When the old device is physically removed from the loop, the control panel will signal the "No answer" fault. When the new device with the same address is connected to the loop, the control panel will restore the "No answer" fault and automatically update its internal database with the new device type.*

It is not possible to substitute new devices (EN54-23) with old ones (they are not EN54-23 approved).

FC410SNM Sounder Notification Module

➤ The FC410SNM Sounder Notification Module is designed to provide an output, in response to a command signalled from a controller, to activate a number of polarised and suppressed sounders. The sounders are powered from an independent power supply and the module is capable of passing up to a maximum of 2A (eg, 24V dc 50mA company sounders or a mixture of different current rated sounders not exceeding a maximum current of 2A).

☞ *The possibility of the configuration of extinction, although present in the FC410SNM module, is not available for FC501 control panel.*

FC410TSM – door control module

The FC410TSM Door Control Module is designed to close a fire door in case of alarm or fault. The door is normally kept open by electromagnets. The door control module disconnects the electromagnets from power supply in order to allow the door to close. The FC410TSM has a relay changeover output and a monitored input. The FC410TSM contains an integrated line isolator and self-monitoring circuits (monitoring of communication with a panel, loop power monitoring), which enables the fire door to be closed when communication with a panel is lost for longer than 45s (± 5 s) or the loop power drops below $U_{min}=19V$ for more than 15s (± 5 s). In addition, the FC410TSM monitors the external 24V supply.

FC410DDM – Universal fire and gas detector module

The FC410DDM provides the ability to connect and interface 2 zones of 20 V DC 2-wire conventional fire detectors, or two 4-20 mA signalling sensors, to the FireClass fire alarm controller. The FC410DDM monitors the status of the detectors and the wiring to the detectors and signals detector and wiring status back to the controller. The conventional detector circuits can be configured to monitor 1 or 2 Class B spur circuits. The 4-20 mA signalling sensors may be one of two types:

- Current sinking
- Current sourcing.

FC410QIO Quad input output module

The module provides four monitored digital inputs and four potential free relay changeover outputs. The outputs are monitored with parallel contacts of the relays. The outputs can be connected to an Auxiliary Voltage source and its voltage can be monitored. Additionally, all the outputs can be connected to the HVR800, for switching high power galvanic isolated loads. For more details refer to the HVR800 documentation. The module has an integral loop isolator. If this activates, a yellow LED illuminates. The activation remains in place until the short is removed. The digital input monitoring and isolator functions are both configurable.

Maximum relay current: 2A.
Maximum relay voltage: 30V.

FC410QRM Quad relay module

The module provides four voltage free relay changeover outputs. The outputs are monitored, with parallel contacts of the relays. The outputs can be connected to an Auxiliary Voltage source and its voltage can be monitored. Additionally, all the outputs are configurable to the HVR (High Voltage Relay) mode, which allows you to connect up to four HVR800 modules for switching; for example 240V loads galvanically isolated. The module has an integral loop isolator. If this activates a yellow LED illuminates. The activation remains in place until the short is removed.

Maximum relay current: 2A.
Maximum relay voltage: 30V.

FC410QMO Quad Monitored Output Module

The module comprises of four relays with selectable wiring supervision.

The output wiring is monitored for any short or open circuit. Spur and Loop configurations are supported.

The module has an integral loop isolator. If this activates, a yellow LED illuminates. The activation remains in place until the short is removed.

SPECIFICATIONS

These specifications are for installers with knowledge of the control panels and fire control panels in general.

Technical features

Some of the technical features, regarding the terminals on the Main, are described in the following table.

Control Panel	FC501-L	FC501-H FC501-HK
Main voltage	110/230 V  60/50 Hz -15/+10%	
Aux. Outputs Nominal Voltage	27.6V	
Aux. Outputs Min. and Max. Voltage	19.0 ÷ 27.6V	
Minimum output voltage	19.0Vdc ± 5 %	
Max current drawn	1.1A (110V) 0.65A (230V)	1.6A (110V) 0.8A (230V)
Ripple	1 %	
Maximum internal resistance of the battery and associated circuitry	1 Ω	
Temperature range	-5 to +40°C	
Storage Temperature	-40 to +80°C	
Operating Humidity	Up to 95% non-condensing	
Dimensions (W*H*D)	335*369*115 mm	
Weight	3 Kg (without batteries)	

Table 12 FC501 Technical features.

The following table shows the technical features of the Repeater FC500REP:

REPEATER	FC500REP
Operating voltage	27.6Vdc
Maximum current	80mA
Temperature range	-5 to +40°
Storage Temperature	-40 to +80 °C
Operating Humidity	Up to 95% non-condensing
Dimensions (W*H*D)	390x215x50 mm
Weight	2.05 Kg

Description of the terminals

The terminals of the Main board and Switching power supply, are described briefly in the Table 13: the standby (normal) status is the first, followed by the alarm status. Moreover, the Voltage present during the different operating conditions is indicated for each terminal, as well as the maximum current (in amps) that can circulate.

☞ Notes (1) and (2) are valid for the table 10.
Notes (3) and (4) are valid for the table:
" MAX WITHDRAWABLE CURRENT"

- 1) For the power supply of the external devices. (see table 11).
- 2) Connect a 3900 ohm resistor between the [+] and [-] terminals of the SC1, SC2 Outputs, if not used (see table 11).
- 3) The sum of the currents of SC1 and SC2 must not exceed 500 mA.
- 4) The sum of the currents of 24A and 24R must not exceed 500 mA.

TERM.	DESCRIPTION	v(V)	i(A)
MAIN BOARDS			
+L1- LEFT	(+)Loop 1-Positive signal, left side. (-)Loop 1-Negative signal (return), left side	—	—
+L1- RIGHT	(+)Loop 1-Positive signal, right side. (-)Loop 1-Negative signal (return), right side	—	—
+L2- LEFT	(+)Loop 2-Positive signal, left side. (-)Loop 2-Negative signal (return), left side.	—	—
+L2- RIGHT	(+)Loop 2-Positive signal, right side. (-)Loop 2-Negative signal (return), right side.	—	—
+L3- LEFT	(+)Loop 3-Positive signal, left side. (-)Loop 3-Negative signal (return), left side.		
+L3- RIGHT	(+)Loop 3-Positive signal, right side. (-)Loop 3-Negative signal (return), right side.		
SH	Terminal for connection of the shield of cables		
+RS485-	SERIAL BUS. Terminals to connect the FC500REP and FC500MFI modules	—	—
[+] [24R]	24 V RESET ABLE AUXILIARY POWER SUPPLY: negative present on terminal [+]; positive present on terminal [24R].	27.6 0	0.5(1) —
[+] [24A]	24 V AUXILIARY POWER SUPPLY: negative present on terminal [+]; positive present on terminal [24A].	27.6 0	0.5(1) —
[LE] [LI] [⊥]	Terminal for connection of the external telephone line Terminal for connection of the internal telephone line Terminal for connection of the Earth cable		
[NC] [NO] [C] FIRE	FIRE ALARM OUTPUT - Non-Supervised: standby → [C] connected to [NC] with [NO] open; in the event of ALARM → [C] connected to [NO] with [NC] open	—	—
[NC] [NO] [C] FAULT	FAULT ALARM OUTPUT - Non-Supervised: standby → [C] connected to [NC] with [NO] open in the event of fault → [C] connected to [NO] with [NC] open	—	—
+BAT-	BATTERY CONTROL PANEL POWER SUPPLY	27.6	
[OC1]... [OC2]	Programmable Outputs(Open collector)- Silenceable-Bypassable (Disabled)-Supervised (The polarity is not programmable)	27.6	
[MIK] [SPK] [BLK] [RED]	FUTURE USE		
[SC1] [SC2]	(Programmable, SC2 only),Supervised, Silenceable, Bypassable (Disabled) ALARM Outputs: Panel in Standby → negative on [+] terminal; positive 27.6V on [-] terminal Panel in Alarm → positive 27.6V on [+] terminal; negative 0 V on [-] terminal	—	(2)

Table 13 Terminals description.

Table of distribution of currents

FC501-L CONTROL PANEL	
SWITCHING POWER SUPPLY BAW50T24 (Imax=1800mA)	
7 Ah BATTERY	$I_{load\ 80\% \text{ in } 24h} = (7 \times 0.8) / 24 = 233mA \rightarrow \mathbf{250mA}$
	$I_{for\ panel} = 1800 - 250 = \mathbf{1550mA}$
	Panel load distribution
	$I_{electronic} = 175mA$
	$I_{total\ LOOPS\ @40V^{(*)}} = 200mA \rightarrow 313mA\ @Vbattery$
	$I_{total\ OUTPUTS^{(*)}} = 850mA$
	$I_{FC500IP} = 100mA^{(**)}$
$I_{residual} = 113mA$	
12Ah BATTERY	$I_{load\ 80\% \text{ in } 24h} = (12 \times 0.8) / 24 = 400mA \rightarrow \mathbf{400mA}$
	$I_{for\ panel} = 1800 - 400 = \mathbf{1400mA}$
	Panel load distribution
	$I_{electronic} = 175mA$
	$I_{total\ LOOPS\ @40V^{(*)}} = 200mA \rightarrow 313mA\ @Vbattery$
	$I_{total\ OUTPUTS^{(*)}} = 750mA$
	$I_{FC500IP} = 100mA^{(**)}$
$I_{residual} = 63mA$	

FC501-H/FC501-HK CONTROL PANEL	
SWITCHING POWER SUPPLY BAW75T24 (Imax=2700mA)	
12 Ah BATTERY	$I_{load\ 80\% \text{ in } 24h} = (12 \times 0.8) / 24 = 400mA \rightarrow \mathbf{400mA}$
	$I_{for\ panel} = 2700 - 400 = \mathbf{2300mA}$
	Panel load distribution
	$I_{electronic} = 175mA$
	$I_{total\ LOOPS\ @40V^{(*)}} = 400mA \rightarrow 625mA\ @Vbattery$
	$I_{total\ OUTPUTS^{(*)}} = 1350mA$
	$I_{FC500IP} = 100mA^{(**)}$
$I_{residual} = 50mA$	
38Ah BATTERY	$I_{load\ 80\% \text{ in } 24h} = (38 \times 0.8) / 24 = 1267mA \rightarrow \mathbf{1300mA}$
	$I_{for\ panel} = 2700 - 1300 = \mathbf{1400mA}$
	Panel load distribution
	$I_{electronic} = 175mA$
	$I_{total\ LOOPS\ @40V^{(*)}} = 200mA \rightarrow 313mA\ @Vbattery$
	$I_{total\ OUTPUTS^{(*)}} = 650mA$
	$I_{FC500IP} = 100mA^{(**)}$
$I_{residual} = 163mA$	

NOTE: (*) I_{total} LOOPS is the sum of the currents absorbed on the three loops;

I_{total} OUTPUTS is the sum of the currents drawn by the terminals SC1, SC2, 24A, 24R, 24V-RS485.

If the FC500IP module will not be used, the relative amount of current (100mA) can be taken from the SC1, SC2, 24A, 24R, 24V-RS485 terminals.

 The notes and the table "Max withdrawable current" apply to the two models of control Panels.

MAX WITHDRAWABLE CURRENT	
TERMINALS	max Current
SC1	500mA
SC2	500mA
24A	500mA
24R	500mA
24V-RS485	500mA



© FireClass

Tyco Fire & Security GmbH
Victor von Bruns-Strasse 21
8212 Neuhausen am Rheinfeld
Switzerland

Tel.: +41 (0)52 633 02 44
Fax: +41 (0)52 633 02 59

www.fireclass.net

ISTISFKEFC501 7.0 120916 V10